

SEALING OF HOUSEHOLD APPLIANCES



Optimum sealing of dishwasher, washing machine and glass ceramic cooktop components

Sealing, bonding and caulking systems for high-quality household appliances and “white goods” have to satisfy a wide range of requirements that make a decisive contribution to functionality, safety and user satisfaction. Foam gaskets, for example, must be watertight when installed, withstand a high temperature range and be resistant to the chemical constituents of washing and cleaning products over the long term.

The leading manufacturers of household appliances have relied on our Formed-In-Place Foam Gasket (FIPFG) sealing technology and wide range of sealing foam systems for many years. The optimally matched material and dosing machine systems ensure precise and efficient sealing. Dishwashers and washing machine components are sealed through an application of process-stable foam that is controlled by contour robots. Frames of glass ceramic cooktops are fitted with foam gaskets to seal the installed appliance tightly within the kitchen countertop.

It does not matter whether your product is manufactured from plastic, glass-ceramic, stainless steel, or anything else, we tailor the formulation of our foam gasket systems specifically to provide the characteristics you require. The diversity of our solutions especially when it comes to developing new designs while protecting device electronics reliably.

Are you looking for a complete system solution to seal your household applications from a single source?

We offer you a perfectly matched sealing solution consisting of a foam gasket material, dosing system and automation. You will get a fully automatic material application and high-precision dosing controlled by contour robots. This will enable you to meet your various technical requirements optimally and reliably.

Do you need an automation system that adapts to your production requirements?

The modular design of our mixing and dosing systems with their peripheral interfaces allows flexible and efficient use and excellent integration into existing production concepts. In addition, our dosing systems are very easy and intuitive to operate offering a continuous process monitoring.

Our solutions provide you exactly the levels of durability, quality and reliability that your customers expect from your products.

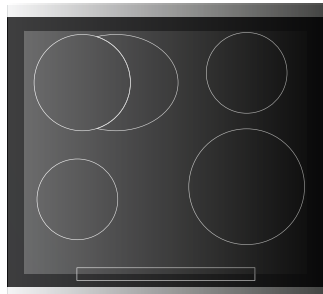

Bespoke sealing solutions for the dishwasher

Silicone foams with high temperature resistance for the sealing of detergent tab housings in dishwashers

The reference material presented here, FERMASIL A-91-VP2 and B-91 (B-component), is a room-temperature-curing 2-component silicone foam for the sealing of detergent tab housings in dishwashers and has already proven itself in many years of use by leading appliance manufacturers. The silicone sealing foam is applied directly to the component using FIPFG (Formed-In-Place-Foam-Gasket) technology and our fully automated dosing machines – very precisely, safely and efficiently.

If desired, we can also customize our silicone sealing foams to meet your specific component requirements. Influencing factors include pot life until start of foaming, curing time, and the viscosity, hardness and adhesion properties. FERMASIL silicone foam compensates for component tolerances when sealing and has a very high temperature resistance from -60 to +180 °C. Thanks to the virtually closed-cell foam structure, it offers a high degree of water tightness. The silicone foam gasket is hydrolytically stable, it is also suitable for use in humid environments and highly resistant to many chemicals.

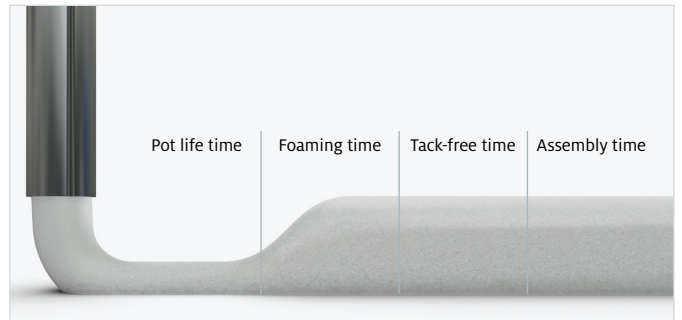

The different reaction phases of the sealing foam in the chronological sequence

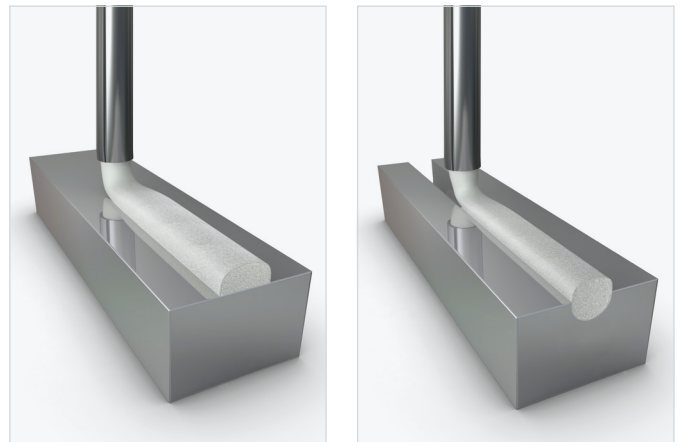

FERMASIL	Dishwasher dosing unit
Mixing ratio	1 : 1
Pot life time	56 sec
Tack-free time	5 min.
Viscosity of the A component	15,000 mPas
Density of the foam	0.3 g/cm ³
Hardness (Shore 00)	52
Temperature resistance	from -60 to +180 °C
Pretreatment	Plasma / Corona / Primer



Cross-section of a silicone foam bead in the groove without pressing



Cross-section of a silicone foam bead in the groove and pressed to approx. 30 %

The very good resetting ability of the FERMASIL silicone foam gasket allow frequent opening and re-closing of the housing, while maintaining a consistent sealing effect of the foam gasket. It exhibits excellent long-term behavior even after years of continuous use.



Silicone foam gasket in the lid groove of the dosing unit for detergent tabs



Circumferential silicone foam gasket for sealing the installed appliance with respect to the stainless steel body

Flexible and fully automatic – fully in line with your requirements

DM 502 mixing and dosing system with 3-axis linear robot for the sealing of detergent tab housings with silicone foam

The reference configuration shown here for true-to-contour application of FERMASIL 2-component silicone sealing foam in the grooves of detergent tab housings in dishwashers consists of the DM 502 mixing and dosing system with an LR-HD 3-axis linear robot and the WT 1-LEVEL shuttle table. Parts are picked up and processed in continuous shuttle mode in one plane. Alternatively, we can offer the WT 2-LEVEL shuttle table with pick-up plates in two planes situated one above the other in shuttle mode.

The highly dynamic LR-HD 3-axis linear robot used or, alternatively, the highly efficient LR-HE plus ensures that the MK 800 PRO precision mixing head is guided over the component true to contour. At the same time, the mixing head applies the silicone foam to the pre-programmed contour fully automatically with high dosing accuracy. After the dosing cycle, the coupling point of the foam gasket closes seamlessly and is thus almost invisible. The applied material foams, expanding to several times its original volume, and forms an elastic soft foam gasket with the desired foam hardness at room temperature.

Our mixing and dosing machines can be operated easily and intuitively without requiring much training. Thanks to the automatic logging of dosing program data, all process data can be traced and evaluated by the machine operator via the CONTROL 2 operating panel while production is running.

In all solutions, our main focus is on extremely reliable plant engineering, minimized maintenance times and consistent dosing quality. As process experts, we support you with tailored advice for the automation of your manufacturing processes.



Optionally available: **CONTROL 2 touchscreen operating panel (21.5")** for operating the dosing system



Optional: **WT 2-LEVEL shuttle / sliding table** with two pick-up plates operating in shuttle mode in two planes



WT 1-LEVEL shuttle / sliding table
Two pick-up plates operating in shuttle mode in one plane



The multi-function **MP 2 mobile panel (10.1" WXGA TFT)** enables convenient operation of the dosing system.

Highly dynamic **LR-HD 3-axis linear robot** for precise guidance of mixing heads for the application of polymer reaction materials. The rack-and-pinion drive with high stiffness and acceleration enables dynamic application speeds.

Optional: Highly efficient **LR-HE plus 3-axis linear robot** for precise guidance of mixing heads for the application of polymer reaction materials. The Omega toothed belt drive enables high application speeds for components with medium and large radii.

Optional: Automatic **SUPPLY TAB drum refilling station** for low-viscosity products, e.g. isocyanate (**B component**)

Optional: Automatic **ELEVATOR drum refilling station** for the **A component** with pneumatic lift and agitator

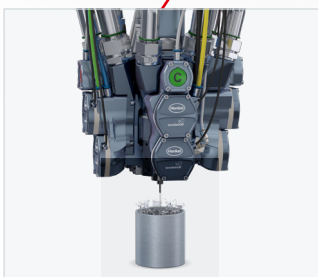
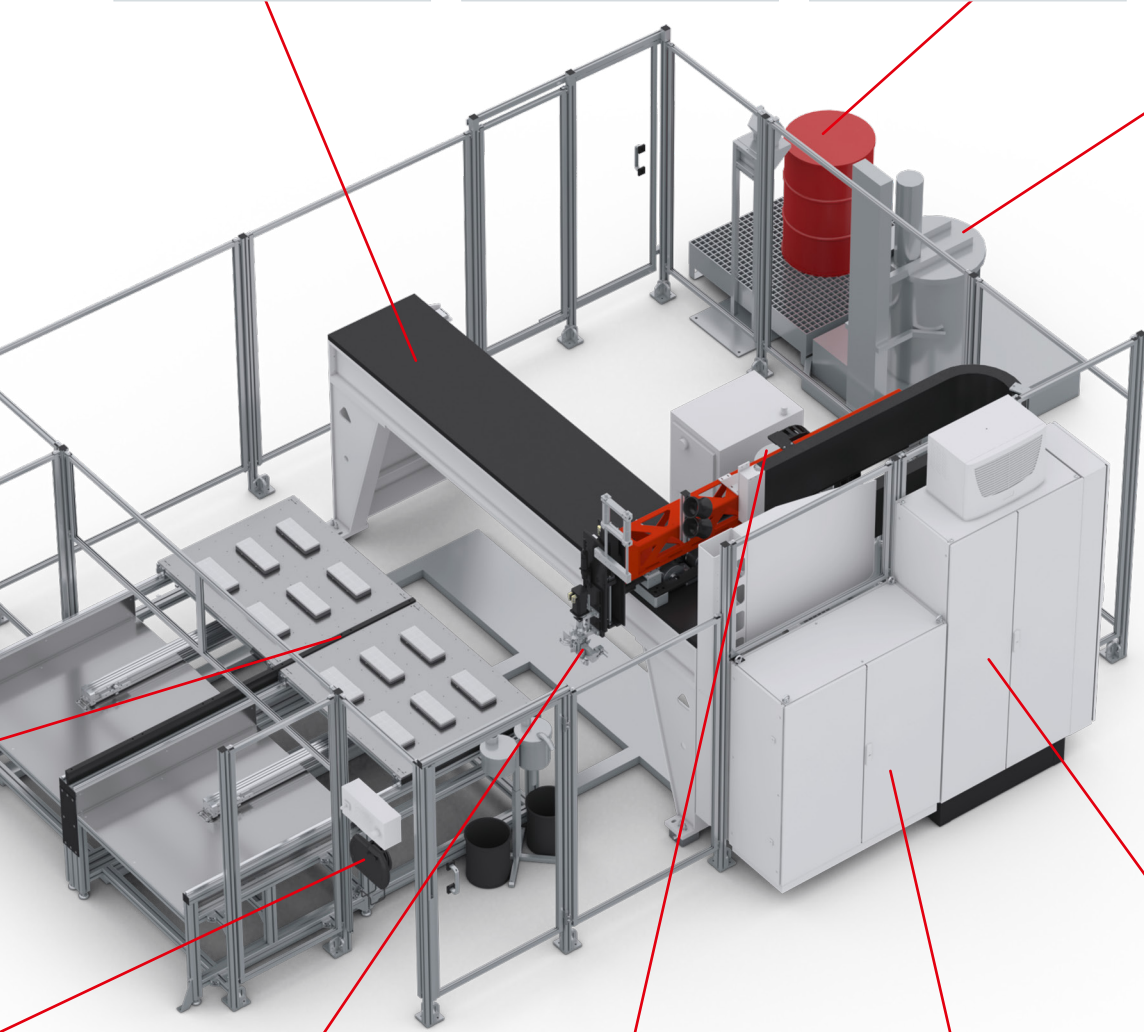
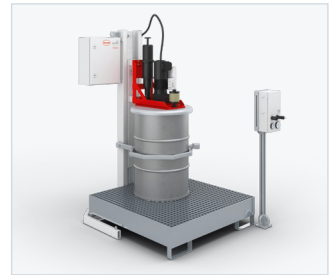

Precision mixing head MK 800 PRO with high-pressure water rinsing



Separately installed **material pressure tanks** (24 l or 44 l, single-walled or double-walled) with minimum level sensors, on a grating platform with adjustable leveling feet and drip tray

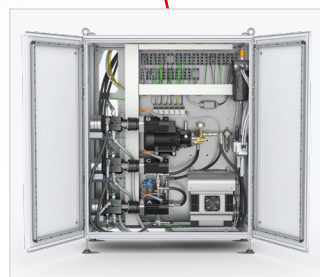

The **dosing machine cabinet** contains the components of the dosing periphery, e.g. the dosing pumps.

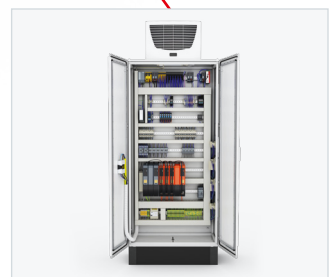

The control electronics, safety engineering and industrial PC are installed in the **control cabinet**.

Bespoke sealing solutions for the dishwasher

Polyurethane foam gaskets for sealing dirt traps in dishwashers

The reference material presented here, FERMAPOR K31-A 9675-2-VP and B-4 (B-component), is a room-temperature-curing 2-component polyurethane foam for the sealing of dirt traps in dishwashers and has already proven itself in many years of use by leading appliance manufacturers. The polyurethane sealing foam is applied directly to the component using FIPFG (Formed-In-Place-Foam-Gasket) technology and our fully automated dosing machines – very precisely, safely and efficiently.

If desired, we can also customize our polyurethane sealing foams to meet your specific component requirements. Influencing factors include pot life until start of foaming, curing time, and the viscosity, hardness and adhesion properties. Thanks to a mixed-cell foam structure, the closing forces when installing the foam gasket are low. FERMAPOR K31 compensates for component tolerances when sealing and has a very high temperature resistance from -40 to +80 °C.

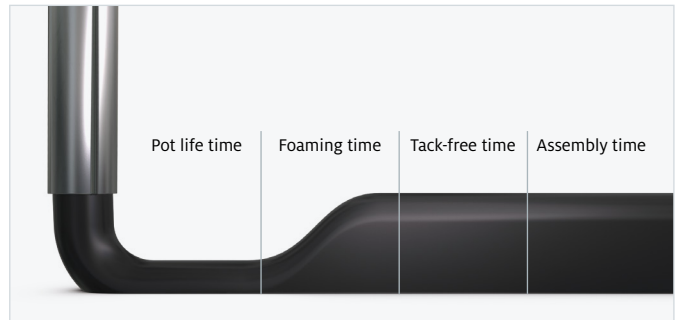

The different reaction phases of the sealing foam in the chronological sequence

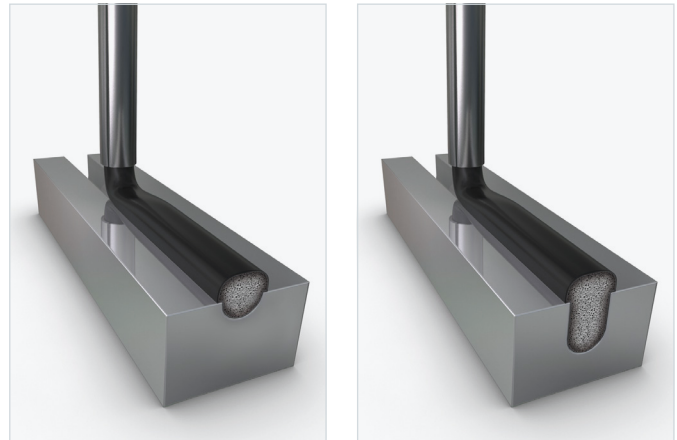

	Dishwasher dirt trap
FERMAPOR	K31-A 9675-2-VP
	B-4
Mixing ratio	4 : 1
Pot life time	38 sec.
Tack-free time	3.5 min.
Viscosity of the A component	1,800 mPas
Density of the foam	0.34 g/cm ³
Hardness (Shore 00)	64
Temperature resistance	from -40 to +80 °C
Pretreatment	Plasma / Corona / Primer



Cross-section of a polyurethane foam bead in the groove without pressing



Cross-section of a polyurethane foam bead in the groove and pressed to approx. 50 %

The good resetting ability of the FERMAPOR K31 polyurethane foam gasket allow frequent removal and reinstallation of the dirt trap for cleaning purposes while maintaining the sealing effect of the foam gasket. It exhibits excellent long-term behavior even after years of continuous use.



Sealing the housing with PU sealing foam from below with respect to the stainless steel body of the dishwasher

Flexible and fully automatic – fully in line with your requirements

DM 502 mixing and dosing system with 3-axis linear robot for the sealing of dirt traps with polyurethane foam

The reference configuration shown here for true-to-contour application of FERMAPOR K31 2-component polyurethane sealing foam in the groove contour of the dirt trap components for dishwashers consists of the DM 502 mixing and dosing system with a 3-axis linear robot and the WT 1-LEVEL shuttle table. Parts are picked up and processed in continuous shuttle mode in one plane. Alternatively, we can offer the WT 2-LEVEL shuttle table with pick-up plates in two planes situated one above the other in shuttle mode.

The highly dynamic LR-HD 3-axis linear robot used or, alternatively, the highly efficient LR-HE plus ensures that the MK 800 PRO precision mixing head is guided over the component true to contour. At the same time, the mixing head applies the polyurethane foam to the pre-programmed contour fully automatically with high dosing accuracy.

After the dosing cycle, the coupling point of the foam gasket closes seamlessly and is thus almost invisible. The applied material foams, expanding to several times its original volume, and forms an elastic soft foam gasket with the desired foam hardness at room temperature. Due to the chemical reaction of the FERMAPOR K31 material components, good adhesion to the component is usually achieved. A cross-linked structure is formed afterwards, which is extremely resistant to moisture and temperature effects.

Our mixing and dosing machines can be operated easily and intuitively without requiring much training. Thanks to the automatic logging of dosing program data, all process data can be traced and evaluated by the machine operator via the CONTROL 2 operating panel while production is running.

In all solutions, our main focus is on extremely reliable plant engineering, minimized maintenance times and consistent dosing quality. As process experts, we support you with tailored advice for the automation of your manufacturing processes.



Optionally available: **CONTROL 2 touchscreen operating panel (21.5")** for operating the dosing system



Optional: **WT 2-LEVEL shuttle / sliding table** with two pick-up plates operating in shuttle mode in two planes



WT 1-LEVEL shuttle / sliding table
Two pick-up plates operating in shuttle mode in one plane



The multi-function **MP 2 mobile panel (10.1" WXGA TFT)** enables convenient operation of the dosing system.

Highly dynamic **LR-HD 3-axis linear robot** for precise guidance of mixing heads for the application of polymer reaction materials. The rack-and-pinion drive with high stiffness and acceleration enables dynamic application speeds.

Optional: Highly efficient **LR-HE plus 3-axis linear robot** for precise guidance of mixing heads for the application of polymer reaction materials. The Omega toothed belt drive enables high application speeds for components with medium and large radii.

Optional: Automatic **SUPPLY TAB drum refilling station** for low-viscosity products, e.g. isocyanate (**B component**)

Optional: Automatic **ELEVATOR drum refilling station** for the **A component** with pneumatic lift and agitator

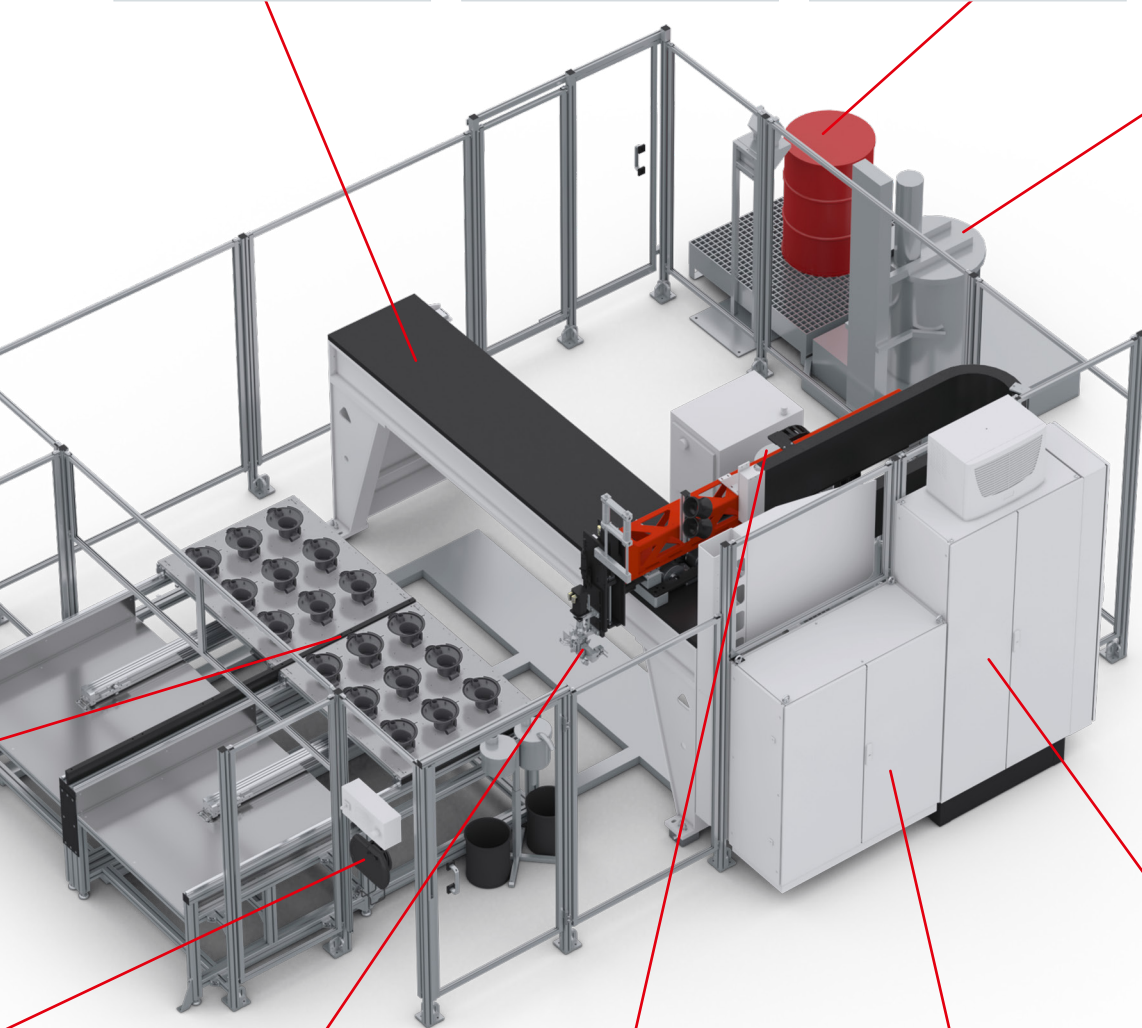
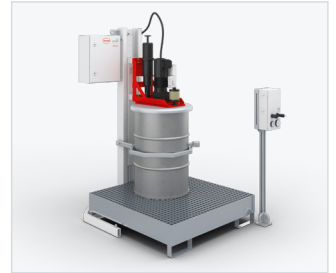

Precision mixing head MK 800 PRO with high-pressure water rinsing



Separately installed **material pressure tanks** (24 l or 44 l, single-walled or double-walled) with minimum level sensors, on a grating platform with adjustable leveling feet and drip tray

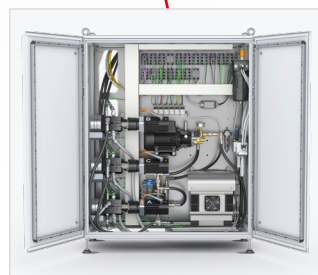

The **dosing machine cabinet** contains the components of the dosing periphery, e.g. the dosing pumps.

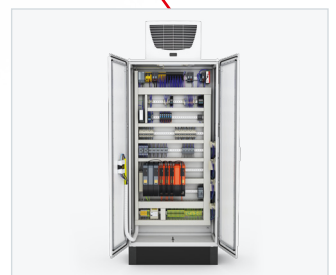

The control electronics, safety engineering and industrial PC are installed in the **control cabinet**.

Bespoke sealing solutions for the washing machine

Polyurethane foam gasket for sealing a service panel in the washing machine rear wall

The reference material presented here, FERMAPOR K31-A 9260-26 and B-N (B-component), is a room-temperature-curing 2-component polyurethane foam for the sealing of service panels in washing machine rear walls. It has already proven itself in many years of use by leading appliance manufacturers. The polyurethane sealing foam is applied directly to the component using FIPFG (Formed-In-Place-Foam-Gasket) technology and our fully automated dosing machines - very precisely, safely and efficiently.

If desired, we can also customize our polyurethane sealing foams to meet your specific component requirements. Influencing factors include pot life until start of foaming, curing time, and the viscosity, hardness and adhesion properties. Thanks to a mixed-cell foam structure, the closing forces when installing the foam gasket are low.

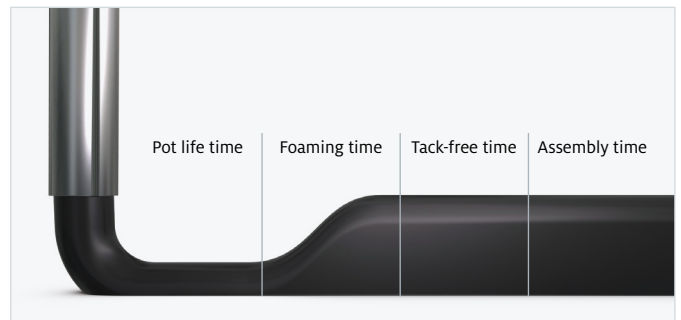

The different reaction phases of the sealing foam in the chronological sequence

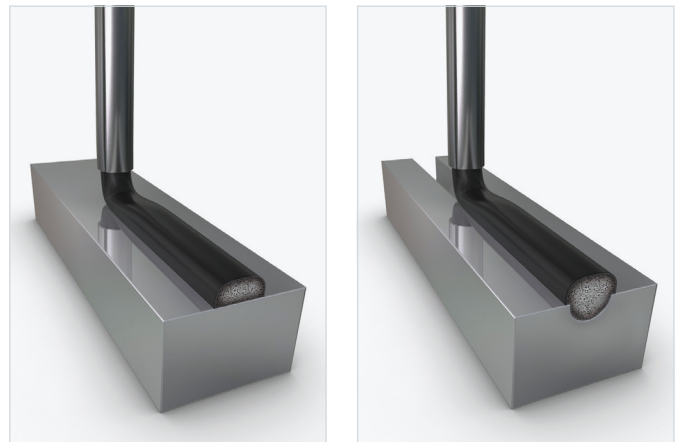

	Service panel in washing machine rear wall
FERMAPOR	K31-A 9260-26
	B-N
Mixing ratio	6 : 1
Pot life time	29 sec.
Tack-free time	4 min.
Viscosity of the A component	33,000 mPas
Density of the foam	0.18 g/cm ³
Hardness (Shore 00)	21
Temperature resistance	from -40 to +80 °C
Pretreatment	Plasma / Corona / Primer



Cross-section of a polyurethane foam bead – unpressed



Cross-section of a polyurethane foam bead with 50% compression

FERMAPOR K31 polyurethane foam gasket compensates for component tolerances during sealing and has a very good resetting ability of the seal foam structure. This allows repeated opening and re-closing of the service panels for maintenance purposes, while maintaining a consistent sealing effect of the foam gasket. It exhibits excellent long-term behavior even after years of continuous use and has good temperature resistance within a range of -40 to +80 °C.

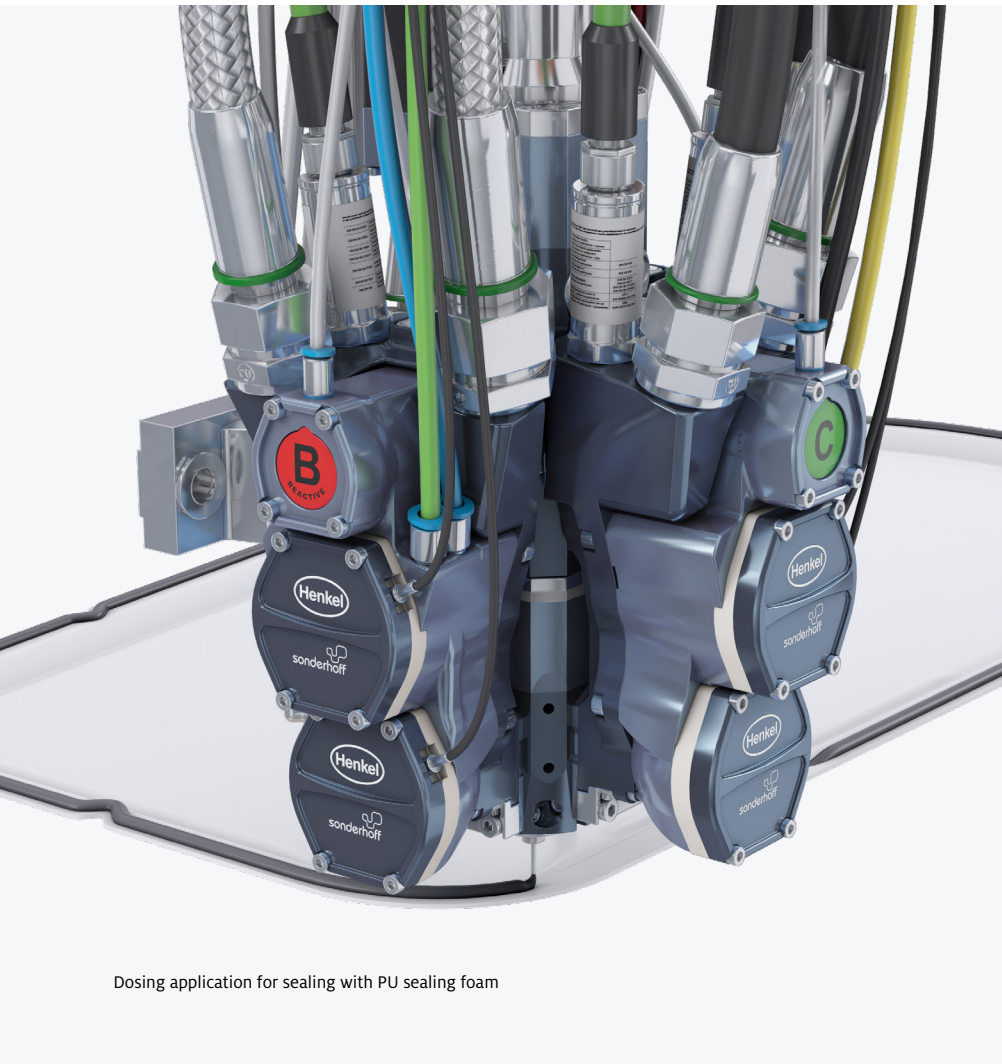

Dosing application for sealing with PU sealing foam

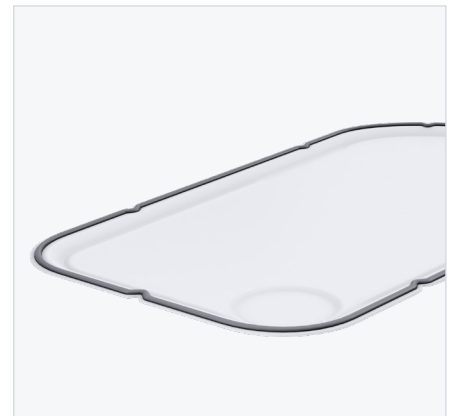

PU foam sealed contour of the service panel in the washing machine rear wall



Service panel installed in rear wall

Flexible and fully automatic – fully in line with your requirements

DM 502 mixing and dosing system with 3-axis linear robot for the sealing of service panels in washing machine rear walls with polyurethane foam

The reference configuration shown here for true-to-contour application of FERMAPOR K31 2-component polyurethane sealing foam to the rear wall covers of washing machines consists of the DM 502 mixing and dosing system with a 3-axis linear robot and the WT 1-LEVEL shuttle table. Parts are picked up and processed in continuous shuttle mode in one plane. Alternatively, we can offer the WT 2-LEVEL shuttle table with pick-up plates in two planes situated one above the other in shuttle mode.

The highly dynamic LR-HD 3-axis linear robot used or, alternatively, the highly efficient LR-HE plus ensures that the MK 800 PRO precision mixing head is guided over the component true to contour. At the same time, the mixing head applies the polyurethane foam to the pre-programmed contour fully automatically with high dosing accuracy.

After the dosing cycle, the coupling point of the foam gasket closes seamlessly and is thus almost invisible. The applied material foams, expanding to several times its original volume, and forms an elastic soft foam gasket with the desired foam hardness at room temperature. Due to the chemical reaction of the FERMAPOR K31 material components, good adhesion to the component is usually achieved. A cross-linked structure is formed afterwards, which is extremely resistant to moisture and temperature effects.

Our mixing and dosing machines can be operated easily and intuitively without requiring much training. Thanks to the automatic logging of dosing program data, all process data can be traced and evaluated by the machine operator via the CONTROL 2 operating panel while production is running.

In all solutions, our main focus is on extremely reliable plant engineering, minimized maintenance times and consistent dosing quality. As process experts, we support you with tailored advice for the automation of your manufacturing processes.



Optionally available: **CONTROL 2 touchscreen operating panel (21.5")** for operating the dosing system



Optional: **WT 2-LEVEL shuttle / sliding table** with two pick-up plates operating in shuttle mode in two planes



WT 1-LEVEL shuttle / sliding table
Two pick-up plates operating in shuttle mode in one plane



The multi-function **MP 2 mobile panel (10.1" WXGA TFT)** enables convenient operation of the dosing system.

Highly dynamic **LR-HD 3-axis linear robot** for precise guidance of mixing heads for the application of polymer reaction materials. The rack-and-pinion drive with high stiffness and acceleration enables dynamic application speeds.

Optional: Highly efficient **LR-HE plus 3-axis linear robot** for precise guidance of mixing heads for the application of polymer reaction materials. The Omega toothed belt drive enables high application speeds for components with high application speeds for components with medium and large radii.

Optional: Automatic **SUPPLY TAB drum refilling station** for low-viscosity products, e.g. isocyanate (**B component**)

Optional: Automatic **ELEVATOR drum refilling station** for the **A component** with pneumatic lift and agitator

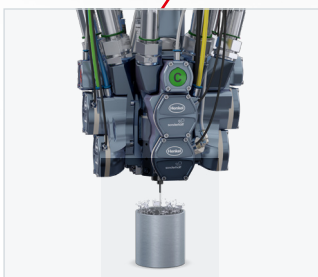
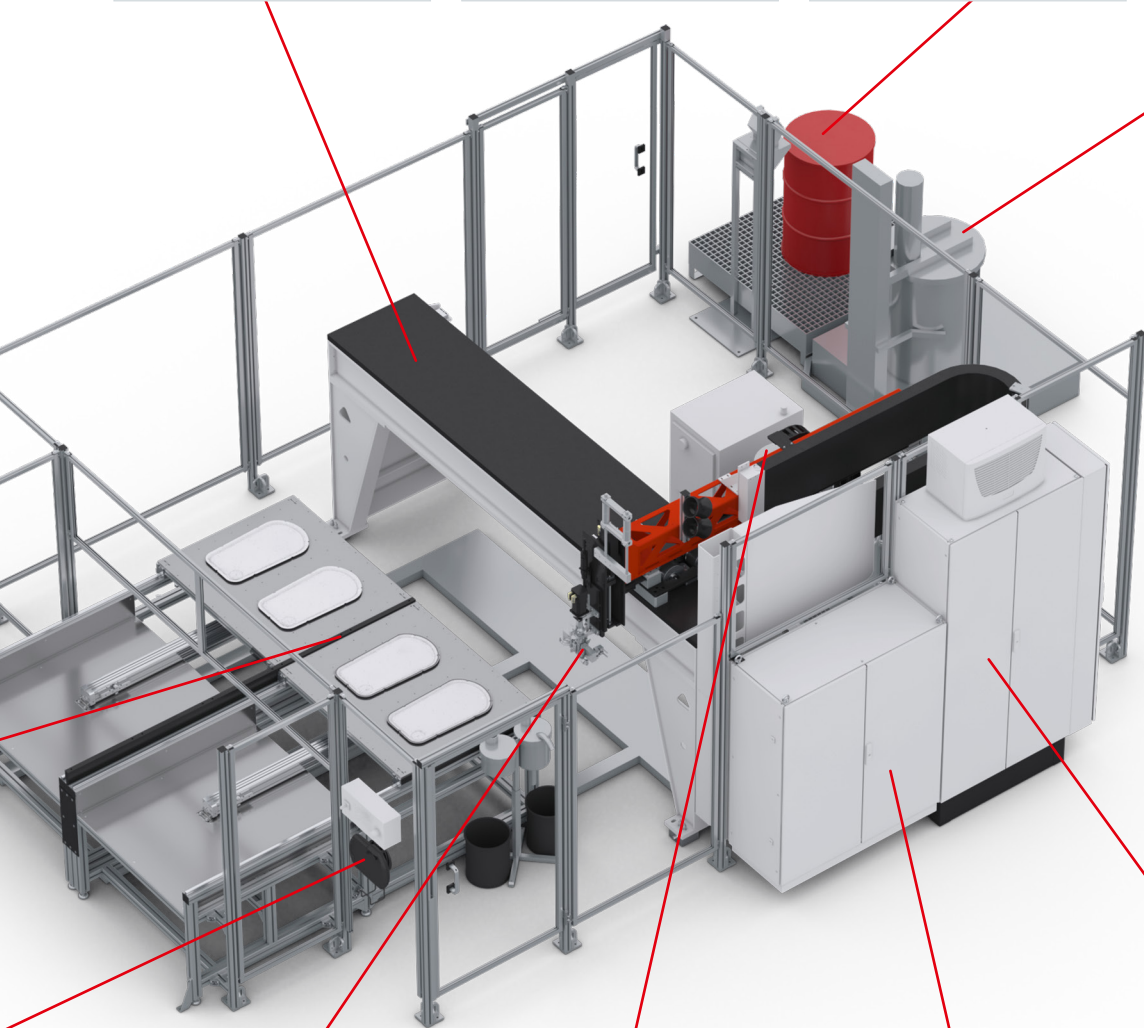
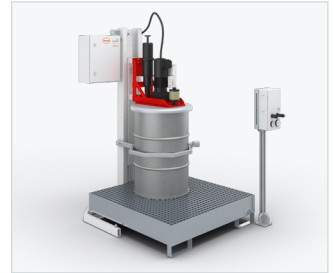

Precision mixing head MK 800 PRO with high-pressure water rinsing



Separately installed **material pressure tanks** (24 l or 44 l, single-walled or double-walled) with minimum level sensors, on a grating platform with adjustable leveling feet and drip tray

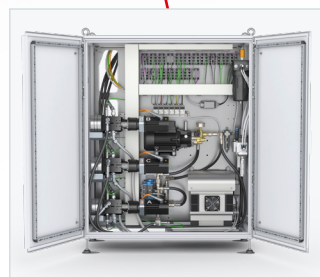

The **dosing machine cabinet** contains the components of the dosing periphery, e.g. the dosing pumps.

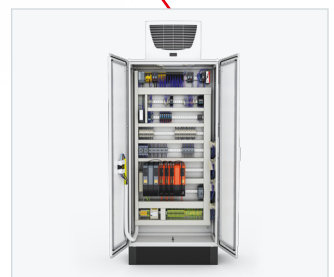

The control electronics, safety engineering and industrial PC are installed in the **control cabinet**.

Bespoke sealing solutions for glass ceramic cooktops

Polyurethane and silicone foam gaskets for the sealing of glass ceramic cooktops

The reference materials presented here, FERMAPOR K31-A 9260-26 and B-N (B-component) made of polyurethane and FERMASIL A-2525-2 and B-2510-1 (B-component) made of silicone, are room-temperature-curing 2-component sealing foams for sealing the frames of glass ceramic cooktops. They have already proven themselves in many years of use by leading appliance manufacturers.

The sealing foam is applied directly to the application surface or in the flat groove of the cooktop frame using FIPFG (Formed-In-Place-Foam-Gasket) technology and our fully automated dosing machines - very precisely, safely and efficiently.

If desired, we can also customize our sealing foam to meet your specific component requirements. Influencing factors include pot life until start of foaming, curing time, and the viscosity, hardness and adhesion properties.

Thanks to its mixed-cell foam structure, the FERMAPOR K31 polyurethane foam gasket has low closing forces during installation and compensates for component tolerances during sealing. It exhibits excellent long-term behavior even after years of continuous use and offers good temperature resistance.

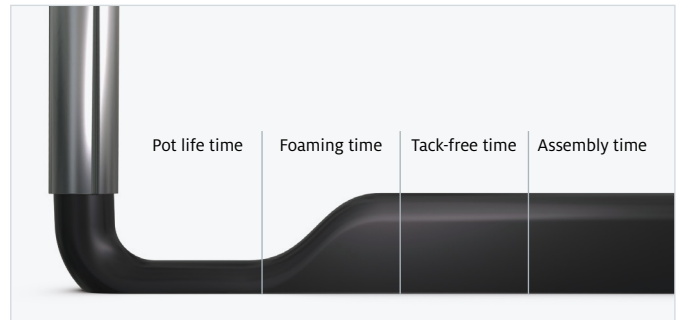

The different reaction phases of the sealing foam in the chronological sequence

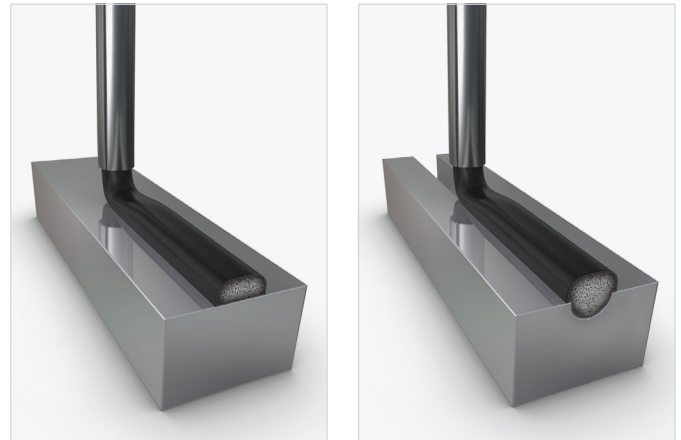

	Glass ceramic cooktop	
	FERMAPOR K31-A 9260-26 FERMAPOR B-N	FERMASIL A-2525-2 FERMASIL B-2510-1
Mixing ratio	6 : 1	1 : 1
Pot life time	29 sec.	70 sec.
Tack-free time	4 min.	18 min.
Viscosity of the A component	33,000 mPas	28,000 mPas
Density of the foam	0.18 g/cm ³	0.28 g/cm ³
Hardness (Shore 00)	21	30
Temperature resistance	from -40 to +80 °C	from -60 to +180 °C



Cross-section of a polyurethane foam bead – unpressed



Cross-section of a polyurethane foam bead with 50% compression



Cross-section of a silicone foam bead in the groove without pressing



Cross-section of a silicone foam bead in the groove and pressed to approx. 30 %

The alternatively available FERMASIL silicone foam also compensates for component tolerances when sealing and offers very high temperature resistance from -60 to +180 °C. Thanks to the virtually closed-cell foam structure, it offers a low level of hygroscopicity when fitted and compressed. The silicone foam gasket is hydrolytically stable, it is also suitable for use in humid environments and highly resistant to many chemicals.



Dosing application of PU or silicone sealing foam into the circumferential groove of the cooktop frame

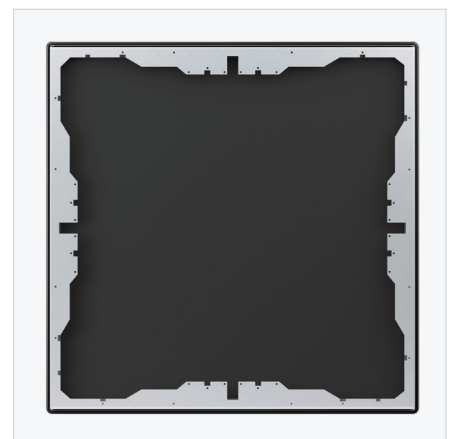

Underside of the cooktop with circumferential frame

Flexible and fully automatic – fully in line with your requirements

DM 502 mixing and dosing system with 3-axis linear robot and a transfer belt for the sealing of glass ceramic cooktops

The reference configuration shown here is used for the true-to-contour application of 2-component sealing foams for sealing glass ceramic cooktops. It consists of the DM 502 mixing and dosing system with a 3-axis linear robot and a transfer belt for the feeding and removal of parts. The cooktop frames are fed to the dosing station at the cycle rate specified for your production, where they pass under the 3-axis linear robot.

An alternative process option to the transfer belt is to use the WT 1-LEVEL shuttle table. Parts are therefore picked up and processed in continuous shuttle mode in one plane. Another option can be to use the WT 2-LEVEL shuttle table with pick-up plates in two planes situated one above the other in shuttle mode.

The highly dynamic LR-HD 3-axis linear robot used or, alternatively, the highly efficient LR-HE plus ensures that the MK 800 PRO precision mixing head is guided over the component true to contour. At the same time, the mixing head applies the sealing foam to the pre-programmed contour fully automatically with high dosing accuracy.

After the dosing cycle, the coupling point of the foam gasket closes seamlessly and is thus almost invisible. The applied material foams, expanding to several times its original volume, and forms an elastic soft foam gasket with the desired foam hardness at room temperature. The gasket is extremely resistant to the effects of moisture and temperature. Due to the chemical reaction of the material components, the sealing foams usually achieve good adhesion to the component.

As process experts, we support you with tailored advice for the automation of your manufacturing processes.



Optional:
Automatic **ELEVATOR** drum refilling station for the **A component** with pneumatic lift and agitator



Optional:
Automatic **SUPPLY TAB** drum refilling station for low-viscosity products, e.g. isocyanate (**B component**)

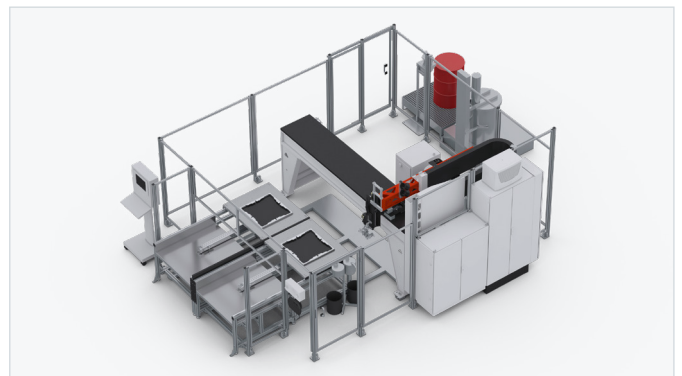

Alternative process option: DM 502 mixing and dosing system with 3-axis linear robot and WT 1-LEVEL shuttle table

Separately installed **material pressure tanks** (24 l or 44 l, single-walled or double-walled) with minimum level sensors, on a grating platform with adjustable leveling feet and drip tray

Optionally available: **CONTROL 2 touchscreen operating panel** (21.5") for operating the dosing system

The **dosing machine cabinet** contains the components of the dosing periphery, e.g. the dosing pumps.

The control electronics, safety engineering and industrial PC are installed in the **control cabinet**.

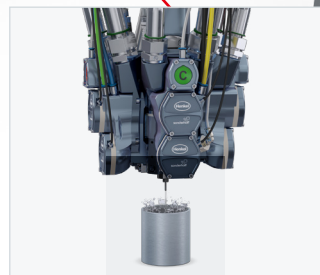
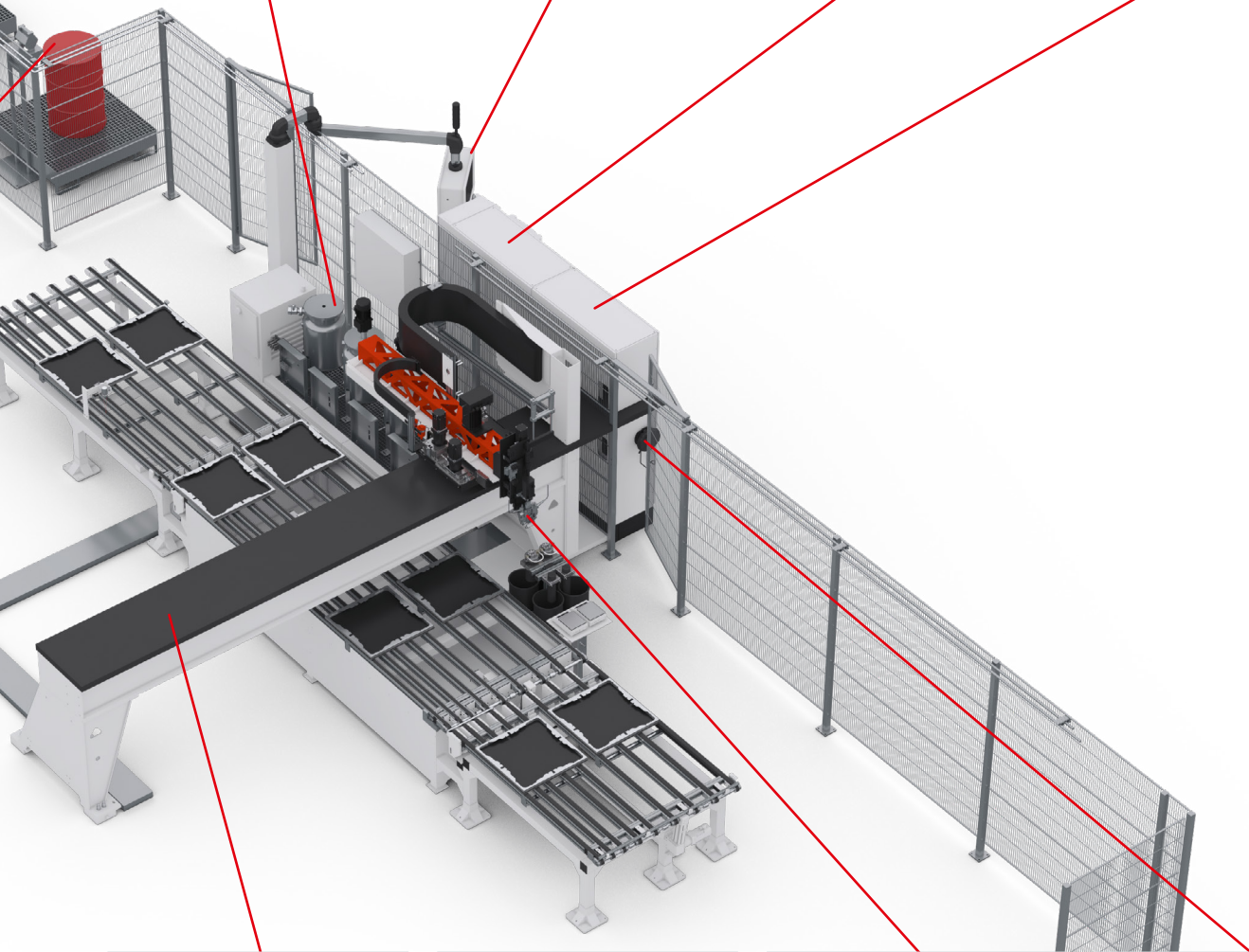
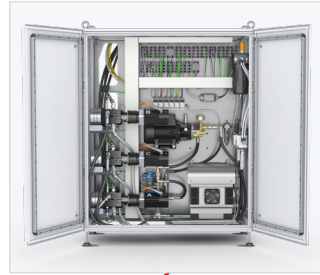

Highly dynamic **LR-HD 3-axis linear robot** for precise guidance of mixing heads for the application of polymer reaction materials. The rack-and-pinion drive with high stiffness and acceleration enables dynamic application speeds.

Optional: Highly efficient **LR-HE plus 3-axis linear robot** for precise guidance of mixing heads for the application of polymer reaction materials. The Omega toothed belt drive enables high application speeds for components with medium and large radii.

Precision mixing head MK 800 PRO with high-pressure water rinsing

The multi-function **MP 2 mobile panel** (10.1" WXGA TFT) enables convenient operation of the dosing system.

The image shows a close-up of a grey industrial machine head with the 'sonderhoff' logo in a teal color. A red, flexible, curved tube is being extruded from the bottom of the machine. The machine has several screws and a textured grey ring around the extrusion point.

sonderhoff

This is why you should use the FIPFG technology
in your production process

- + Advantages of the Formed-In-Place Foam Gasket Technology**
- › Sealing standard in many industrial sectors
 - › Highly accurate material application controlled by contour robots
 - › Processing and full curing at room temperature
 - › Perfect coordination of the material system and dosing system
 - › Suitable for 2D and complex 3D part geometries
 - › More efficient use of materials compared to punched seals
 - › Cheaper compared to 2-C injection molding, as there are no tooling costs
 - › High degree of future viability, due to suitability for use in a wide variety of industries & applications



Advantages of our mixing and dosing machines

- › Combination of processes (bonding, foaming, caulking, potting)
- › High flexibility of the dosing system
- › Simple, intuitive operation
- › Automatic material preparation incl. handling
- › High dosing and repeat accuracy
- › Short machine downtimes and cycle times
- › Fine-cell foam structure due to dynamic mixing
- › Reproducible foam quality
- › Ecological high-pressure water rinsing
- › Easy maintenance



Advantages of our FIPFG foam gaskets

- › More cost-effective than compact systems due to lower foam density
- › Seamless seal / hardly visible coupling point
- › Compensation of component tolerances
- › Good resilience
- › Multiple compression and release processes possible
- › Broad range of properties / wide variety of recipes
- › Individually adaptable recipes
- › Good form fit to the component contour
- › Resistant to moisture, dust, temperature & media
- › Flame-retardant according to UL 94
- › IP classes up to IP 68 or NEMA 4 to 6 and NEMA 12
- › Special PU foam with low VOC emissions
- › Very fast reacting PU foam (Fast-Cure)

Perfectly coordinated solutions of material, machine and contract manufacturing

With its Sonderhoff brand, Henkel has not only acquired many years of experience in the manufacture of tailor-made two-component sealing systems and mixing and dosing machines, but also as a process expert for application-specific material application using the FIPFG (Formed-In-Place-Foam-Gasket) technology.

With the Sonderhoff portfolio, we offer you the advantages of a system provider from a single source and the solutions to meet your technical and commercial challenges.

With the dosing technology that is tailored to our sealing foams, we ensure efficient production processes in accordance with the requirements of fully automated series production.

If you would like to take advantage of all the benefits of the FIPFG technology for your production in a flexible, fast, uncomplicated manner and without having to make your own acquisition investments, we can provide expert sealing for your components at one of our contract manufacturing sites worldwide. There, the spectrum ranges from the sampling of prototypes and small batch series to production scale manufacturing.

The choice is yours! You can either decide in favor of our all-inclusive package, consisting of material, machine and contract manufacturing, supported by application advice, sampling and training or you can choose the individual solutions that suit you best. We combine our products and services from a single source in such a way that you receive the optimum solution for your requirements profile.

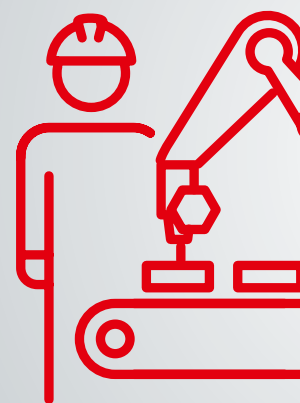

MANUFACT

Flexibility & Precision

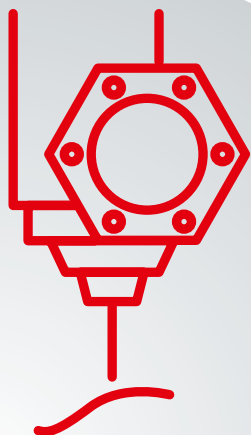

EQUIPMENT

Automation Solutions

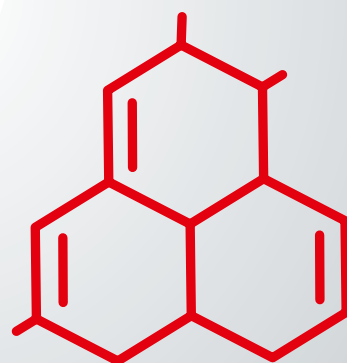

MATERIALS

URING

Customer-specific solutions – worldwide and for many industries

The Henkel specialists for the Sonderhoff portfolio
are available globally

KOLO, POLAND
External Subcontracting Location

DÜSSELDORF, GERMANY
Center of Expertise

ELGIN, ILLINOIS, USA
Regional Hub

RICHMOND (KANSAS CITY), USA
Regional Hub

DORNBIRN, AUSTRIA
Center of Expertise

BARCELONA, SPAIN
External Subcontracting Location

OGGIONO, ITALY
Regional Hub

INCHEON, KOREA
External Subcontracting Location

SHANGHAI, CHINA
Regional Hub

PUNE, INDIA
Regional Hub

PUNE, INDIA
External Subcontracting Location

SÃO PAULO, BRAZIL
External Subcontracting Location

Global presence



Every year, more than 300 million seals are manufactured in more than 50 countries using products from Henkel's Sonderhoff portfolio. At our Centers of Expertise and Regional Hubs, our specialists offer application engineering advice, e.g. selecting a suitable material system and sampling of your components, as well as project management for dosing systems and automation. You will receive training from us on how to use the FIPFG technology and we will support you with the selection of spare parts and a regular service offering. Furthermore, we will be pleased to take over parts of your production for you – from small to large series – at our subcontracting locations.

Sales staff at all other Henkel locations worldwide will also be happy to answer any questions and provide you with further information on our sealing, bonding, and potting solutions. We look forward to hearing from you.



Henkel Corporation

One Henkel Way
Rocky Hill, CT 06067
United States
Tel.: +1 860 571 5100
Fax: +1 860 571 5465

www.henkel-northamerica.com

www.henkel-adhesives.com

www.sonderhoff.us

Get in contact with us



The data contained herein are furnished for information only and are believed to be reliable. We cannot assume responsibility for the results obtained by others over whose methods we have no control. It is the user's responsibility to determine suitability for the user's purpose of any production methods mentioned herein and to adopt such precautions as may be advisable for the protection of property and of persons against any hazards that may be involved in the handling and use thereof. In light of the foregoing, Henkel Corporation specifically disclaims all warranties expressed or implied, including warranties of merchantability or fitness for a particular purpose, arising from sale or use of Henkel Corporation's products. Henkel Corporation specifically disclaims any liability for consequential or incidental damages of any kind, including lost profits. The discussion herein of various processes or compositions is not to be interpreted as representation that they are free from domination of patents owned by others or as a license under any Henkel Corporation patents that may cover such processes or compositions. We recommend that each prospective user test his proposed application before repetitive use, using this data as a guide. This product may be covered by one or more United States or foreign patents or patent applications. The information, product features and pictures contained in this brochure are intended exclusively as a technical guide. Henkel is not responsible for any technical changes or print / typographical errors. Reproduction in whole or in part is prohibited without the prior written consent of Henkel AG & Co. KGaA. Except as otherwise noted, all marks used are trademarks and / or registered trademarks of Henkel and its affiliates in Germany, the U.S., and elsewhere.

© 8.2024 Henkel AG & Co. KGaA. All rights reserved