

BATTERY HOUSING SEALING FOR ROBOTIC LAWN MOWERS AND SMALL DEVICES



System solutions for sealing battery housings for small electronic devices

As in the transport sector and many other areas of the economy and society, electrification based on new battery technologies has also found its way into private households. Practical small appliances operated with cordless, rechargeable batteries are enjoying increasing popularity there, for the garden and in the do-it-yourself workshop, such as robotic lawn mowers, hedge trimmers, leaf blowers, and cordless screwdrivers and drills.

Our sealing and insulating material systems ensure that their batteries and electronics are reliably protected against corrosion by moisture and other external influences. For sealing the battery housings, we offer our 2-component FERMAPOR K31 polyurethane-based sealing foams. The foam gasket is seamlessly applied with our fully automatic dosing machine, providing excellent sealing in the installed state due to compression of the foam structure. In order to seal the electrical connections and electronics of small appliances against moisture and shocks, our 2-component polyurethane potting systems are used.

The material systems for foam gasket and potting can also be processed in combination with a mixing and dosing system for 3 components.

When it comes to sealing your battery housings and potting your electronics, are you looking for a solution consisting of a material system, dosing system and process automation from a single source?

We will provide you with a perfectly coordinated system solution, consisting of a sealing foam or potting material that satisfies your requirements, and a dosing system for high-precision, fully automatic material application, controlled by contour robots.

Do you need an automation system that adapts to your production requirements?

The modular design of our mixing and dosing systems with their peripheral interfaces allows flexible use, with excellent integration into existing production concepts. These can be operated easily and intuitively without requiring much training. Our CNC-controlled mixing and dosing systems offer high levels of repeatability and dosing accuracy, and thanks to systematic process monitoring they are highly efficient.

Our solutions therefore offer you precisely the levels of durability, quality and reliability that your customers expect from your products.



Tailored material systems for maximum product safety

We carry out developments individually for your specific requirements

The reference material presented here, FERMAPOR K31-A-9675-5-VP and B-4 (B component) for sealing the battery housing covers of robotic lawn mowers, is a 2-component polyurethane sealing foam that has been used by leading equipment manufacturers for many years, and is tried and tested. It prevents the penetration of moisture into the battery housing to prevent corrosion, and it protects against dust, dirt and other foreign bodies.

Alternatively, we can also customize our sealing foams to meet your component requirements. Influencing factors include pot life until start of foaming, curing time, and the viscosity, hardness and adhesion properties. Thanks to the mixed-cell foam structure, the closing forces when installing the foam gasket are low.

The precision-contour, robot-controlled Formed-In-Place-Foam-Gasket (FIPFG) application process is crucial in precisely applying sealing foams into the groove of battery housing covers. This is done with our fully automatic DM 502 mixing and dosing machine.

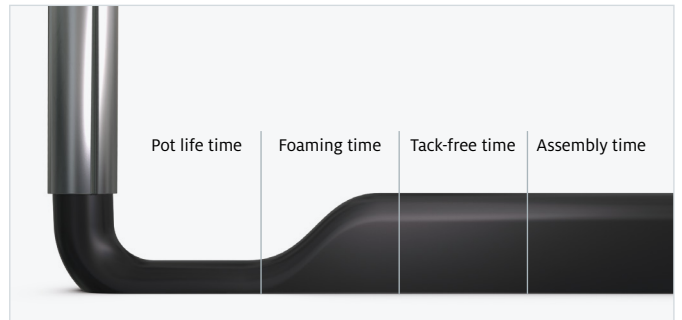

The different reaction phases of the sealing foam in the chronological sequence

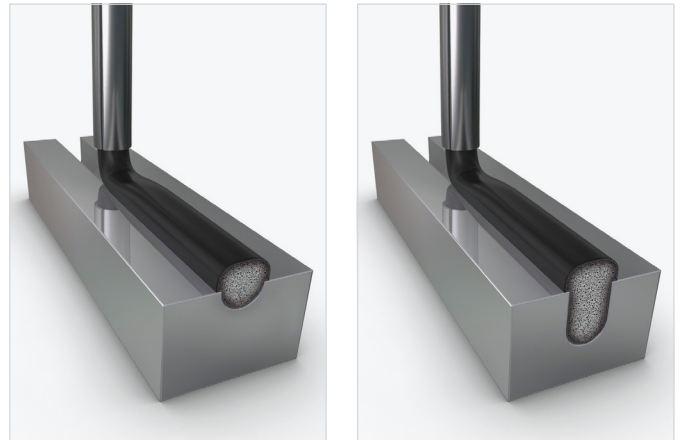

FERMAPOR K31-	A-9675-5-VP B-4
Mixing ratio	4.5 : 1
Pot life time	40 sec.
Tack-free time	7 min.
Viscosity of the A component	1,500 mPas
Density of the foam	0.23 g/cm ³
Hardness (Shore 00)	43
Temperature resistance	from -40 to +80 °C
Pretreatment	Adheres well to powder-coated surfaces. To improve adhesion on plastic and metal surfaces, pretreatment can be carried out using flame, corona, primer or plasma.



Cross-section of a polyurethane foam bead in groove uncompressed



Cross-section of a polyurethane foam bead in the groove and compressed to approx. 50%

During final assembly of the battery housing cover, the foam gasket applied is evenly compressed over the entire length and – once installed – will result in a high degree of tightness in accordance with IP protection classes. It compensates for component tolerances when sealing and has high temperature resistance from -40 to +80 °C. FERMAPOR K31-A-9675-5-VP generally achieves good adhesion on powder coatings and plastics. In special cases, adhesion can be further improved by flame, corona, primer or plasma application.

Due to its excellent shape recovery characteristics, the mixed-cell foam structure of the polyurethane seal can still be compressed well even after years (tested according to DIN EN ISO 1856). It is therefore possible to repeatedly open and close the battery housing cover for battery changes, and the sealing effect of the foam gasket remains consistent.



Dosing application of PU sealing foam into the cover groove of the battery housing via the CNC-controlled mixing head



PU foam sealed battery housing cover for robotic lawn mower

Flexible and fully automatic – fully in line with your requirements

Mixing and dosing system with 3-axis linear robot and a shuttle table for picking up parts

The reference configuration shown here for sealing the battery housings of robotic lawn mowers consists of the DM 502 mixing and dosing system with the MK 825 PRO precision mixing head as well as the LR-HE plus 3-axis linear robot and WT 1-LEVEL shuttle table for holding parts. The two pick-up plates working in shuttle mode enable the workpieces to be picked up and alternately processed in a single plane. This makes it possible to guarantee continuous operation.

The battery housing cover to be sealed is positioned and fixed in place on the shuttle table either by a machine operator, who can also check the parts for quality, or alternatively by a Pick & Place Robot. In the latter case, an optionally installed camera or sensor system could carry out the quality control of the parts.

For the battery housings, sealing material is dispensed into the groove contour of the cover via the CNC-controlled MK 825 PRO precision mixing head. The dosing process must be very precise here. After the dosing cycle, the coupling point of the room-temperature curing foam gasket closes seamlessly and is thus almost invisible. Even with short cycle times and high unit numbers, the material application process using the FIPFG method is carried out with high dosing precision and repeat accuracy. As a result, you achieve foam gaskets of uniformly high quality.

In addition, our fail-safe mixing and dosing system can be operated easily and intuitively without the need for extensive training. Thanks to the automatic logging of dosing program data, all process data can be traced and evaluated by the machine operator via the CONTROL 2 operating panel while production is running.

In all solutions, our main focus is on extremely reliable plant engineering, minimized maintenance times and consistent dosing quality. As a process expert, we support you with individual consulting for the customized automation of your manufacturing processes.



MK 825 PRO precision mixing head
with high-pressure water rinsing



Optionally available: **CONTROL 2**
touchscreen operating panel (21.5")
for operating the dosing system



WT 1-LEVEL shuttle / sliding table
Two pick-up plates operating in shuttle
mode in one plane



Highly efficient **LR-HE plus 3-axis linear robot** for precise guidance of mixing heads for the application of polymer reaction materials. The Omega toothed belt drive enables high application speeds for components with medium and large radii.

Optional: Highly dynamic **LR-HD 3-axis linear robot** for precise guidance of mixing heads for the application of polymer reaction materials. The rack-and-pinion drive with high stiffness and acceleration enables dynamic application speeds.

Optional: Automatic **SUPPLY TAB drum refilling station** for low-viscosity products, e.g. isocyanate (**B component**)

Optional: Automatic **ELEVATOR drum refilling station** for the **A component** with pneumatic lift and agitator

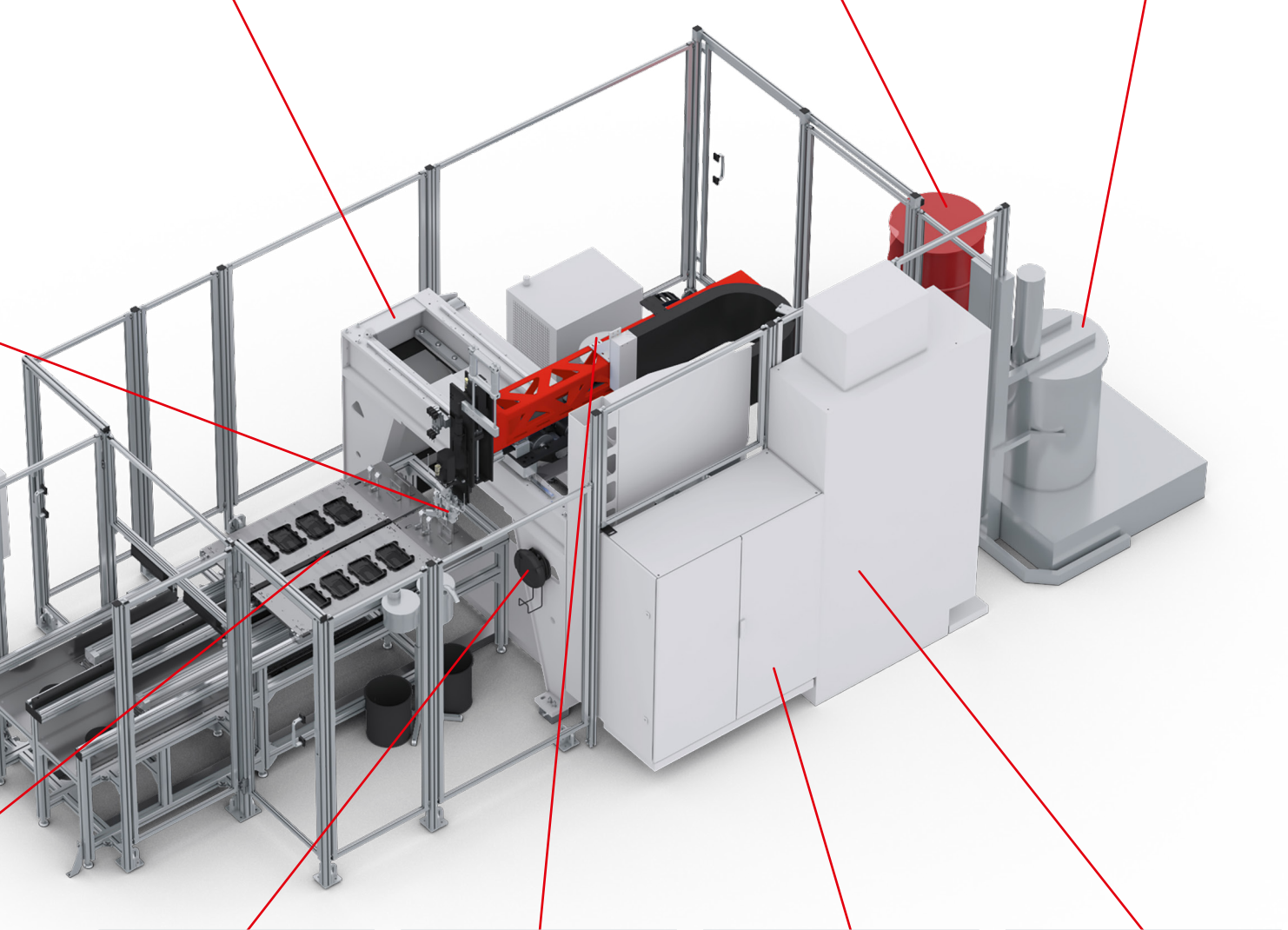

The multifunctional **MP 2 mobile panel** (10.1" WXGA TFT) enables convenient operation of the dosing system.



Separately installed **material pressure tanks** (24 l or 44 l, single-walled or double-walled) with minimum level sensors, on a grating platform with adjustable leveling feet and drip tray

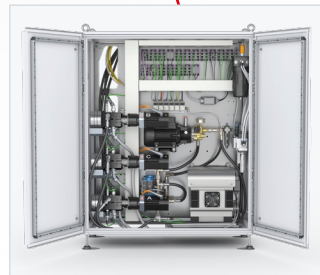

The **dosing machine cabinet** contains the components of the dosing periphery, e.g. the dosing pumps.

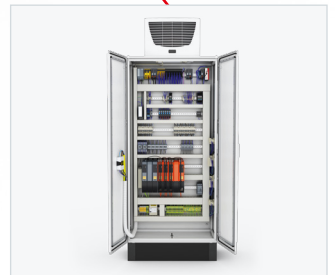

The control electronics, safety engineering and industrial PC are installed in the **control cabinet**.

This is why you should use the FIPFG technology in your production process



Advantages of the Formed-In-Place Foam Gasket Technology

- › Sealing standard in many industrial sectors
- › Highly accurate material application controlled by contour robots
- › Processing and full curing at room temperature
- › Perfect coordination of the material system and dosing system
- › Suitable for 2D and complex 3D part geometries
- › More efficient use of materials compared to punched seals
- › Cheaper compared to 2-C injection molding, as there are no tooling costs
- › High degree of future viability, due to suitability for use in a wide variety of industries & applications



Advantages of our mixing and dosing machines

- › Combination of processes (bonding, foaming, caulking, potting)
- › High flexibility of the dosing system
- › Simple, intuitive operation
- › Automatic material preparation incl. handling
- › High dosing and repeat accuracy
- › Short machine downtimes and cycle times
- › Fine-cell foam structure due to dynamic mixing
- › Reproducible foam quality
- › Ecological high-pressure water rinsing
- › Easy maintenance



Advantages of our FIPFG foam gaskets

- › More cost-effective than compact systems due to lower foam density
- › Seamless seal / hardly visible coupling point
- › Compensation of component tolerances
- › Good resilience
- › Multiple compression and release processes possible
- › Broad range of properties / wide variety of recipes
- › Individually adaptable recipes
- › Good form fit to the component contour
- › Resistant to moisture, dust, temperature & media
- › Flame-retardant according to UL 94
- › IP classes up to IP 68 or NEMA 4 to 6 and NEMA 12
- › Special PU foam with low VOC emissions
- › Very fast reacting PU foam (Fast-Cure)

Perfectly coordinated solutions of material, machine and contract manufacturing

With its Sonderhoff brand, Henkel has not only acquired many years of experience in the manufacture of tailor-made two-component sealing systems and mixing and dosing machines, but also as a process expert for application-specific material application using the FIPFG (Formed-In-Place-Foam-Gasket) technology.

With the Sonderhoff portfolio, we offer you the advantages of a system provider from a single source and the solutions to meet your technical and commercial challenges.

With the dosing technology that is tailored to our sealing foams, we ensure efficient production processes in accordance with the requirements of fully automated series production.

If you would like to take advantage of all the benefits of the FIPFG technology for your production in a flexible, fast, uncomplicated manner and without having to make your own acquisition investments, we can provide expert sealing for your components at one of our contract manufacturing sites worldwide. There, the spectrum ranges from the sampling of prototypes and small batch series to production scale manufacturing.

The choice is yours! You can either decide in favor of our all-inclusive package, consisting of material, machine and contract manufacturing, supported by application advice, sampling and training or you can choose the individual solutions that suit you best. We combine our products and services from a single source in such a way that you receive the optimum solution for your requirements profile.

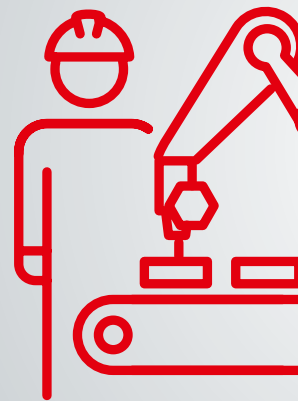

MANUFACT

Flexibility & Precision

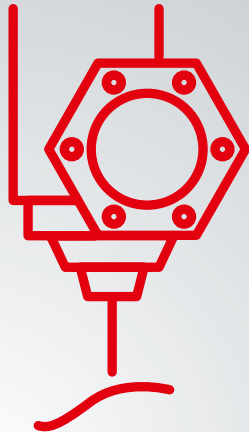

EQUIPMENT

Automation Solutions

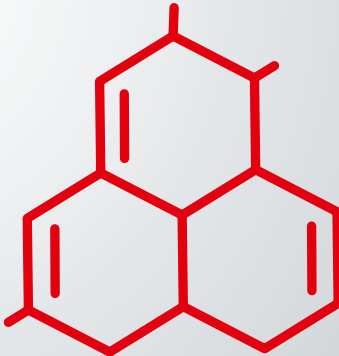

MATERIALS

MANUFACTURING

Customer-specific solutions – worldwide and for many industries

The Henkel specialists for the Sonderhoff portfolio
are available globally

KOLO, POLAND
External Subcontracting Location

DÜSSELDORF, GERMANY
Center of Expertise

ELGIN, ILLINOIS, USA
Regional Hub

RICHMOND (KANSAS CITY), USA
Regional Hub

DORNBIRN, AUSTRIA
Center of Expertise

BARCELONA, SPAIN
External Subcontracting Location

OGGIONO, ITALY
Regional Hub

INCHEON, KOREA
External Subcontracting Location

SHANGHAI, CHINA
Regional Hub

PUNE, INDIA
Regional Hub

PUNE, INDIA
External Subcontracting Location

SÃO PAULO, BRAZIL
External Subcontracting Location

Global presence



Every year, more than 300 million seals are manufactured in more than 50 countries using products from Henkel's Sonderhoff portfolio. At our Centers of Expertise and Regional Hubs, our specialists offer application engineering advice, e.g. selecting a suitable material system and sampling of your components, as well as project management for dosing systems and automation. You will receive training from us on how to use the FIPFG technology and we will support you with the selection of spare parts and a regular service offering. Furthermore, we will be pleased to take over parts of your production for you – from small to large series – at our subcontracting locations.

Sales staff at all other Henkel locations worldwide will also be happy to answer any questions and provide you with further information on our sealing, bonding, and potting solutions. We look forward to hearing from you.



Henkel AG & Co. KGaA

Henkelstraße 67
40589 Düsseldorf
Germany
Tel.: +49 211 797-0
Fax: +49 211 798 4008

www.henkel.com
www.sonderhoff.com

Get in contact with us



The description of the possible fields of use of our products as well as the technical data and values only have a general character and do not mean that a certain product can be used under all conditions in the respective field of use. In this respect, the stated field of use is not a binding specification or usage provision. Due to the great number of environment variables and their influences (e.g. temperature, test specimens, size, interaction with substrates, influence of machines, or the like) you as our customer must check whether the product is suitable for your specific field of use. We will be pleased to assist and advise you in this respect. Except as otherwise noted, all marks used above are trademarks and/or registered trademarks of Henkel and its affiliates in the U.S., Germany and elsewhere.

© 8.2024 Henkel AG & Co. KGaA. All rights reserved