

SEALING OF ELECTRIC MOTORS

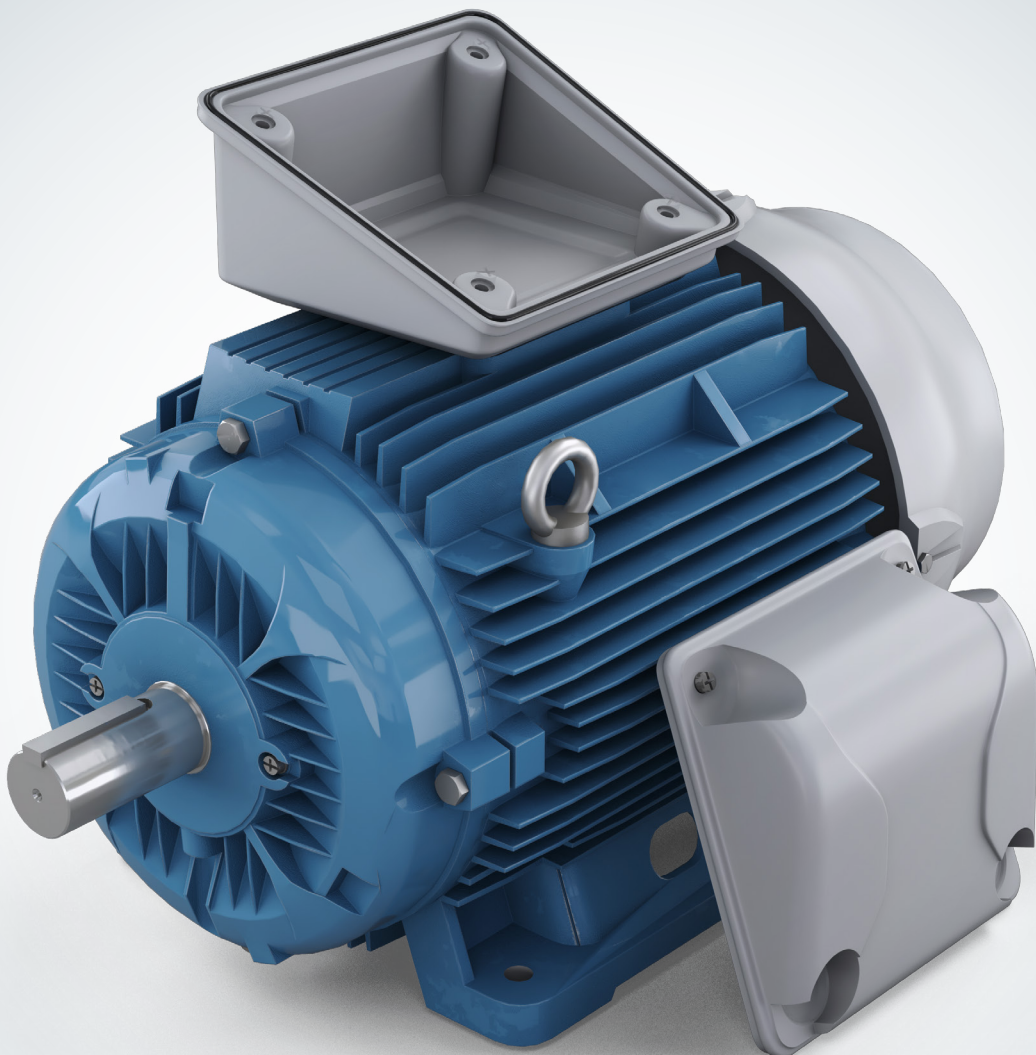

Watertight protection for the terminal box of electric motors

Whenever something turns or moves at the touch of a button, whether in private households, in industry, or in other areas, there are probably electric motors at work. Though often hidden, quiet and inconspicuous, they often do their work for years on end without us giving it much thought. It has become impossible to imagine our modern world without them, however. They can be found in household tools and washing machines, kitchen and garden appliances, and are used for window blinds, awnings, garage doors and many other applications.

Electric motors are used to convert electrical energy into mechanical energy, which is then used to perform mechanical work. Electric motors in industry have very different requirements – electrical drive systems are therefore used in different types of motors, e.g. for conveyor belts, cranes, construction elevators, industrial robots, tool drives, fans, and pumps. The terminal box is responsible for the electricity supply of the electric motor. The power connection here needs to establish and maintain a permanently safe electrical connection.

No moisture, dirt or other foreign bodies can therefore be permitted to enter the terminal box. The terminal box must be sealed to be dust-proof and watertight in compliance with DIN 42925. For this purpose, we offer our 2-component FERMAPOR K31 polyurethane-based sealing foams. The applied foam gasket provides excellent sealing in the installed state due to compression of the foam structure.

Are you looking for a complete system solution for sealing terminal boxes for the electrical supply of electric motors, consisting of a material system, dosing system and process automation from a single source?

We will provide you with a perfectly coordinated sealing solution, consisting of a sealing foam that satisfies your requirements and a dosing system for high-precision, fully automatic material application, controlled by contour robots.

Do you require a flexible automation system that can be variably adapted to your production conditions?

The modular design of our mixing and dosing systems with their peripheral interfaces allows flexible use, with excellent integration into existing production concepts. With its high dispensing accuracy and systematic, sensor based process monitoring our efficient mixing and dosing system is very easy and intuitive to operate.



Tailored material systems for maximum product safety

We carry out developments individually for your specific requirements

The terminal box for the electrical supply of electric motors is sealed against the penetration of moisture, dirt and other foreign bodies with our 2-component FERMAPOR K31 polyurethane foams.

The reference material presented has been tried and tested for many years, and is used by leading manufacturers. Alternatively, we can also optimally adapt our FERMAPOR K31 2-component sealing foams to meet your requirements. Influencing factors include, for example, pot life until start of foaming, curing time, and the viscosity, hardness and adhesion properties. Thanks to the mixed-cell foam structure, the closing forces when installing the foam gasket are low.

FERMAPOR K31 FAST-CURE foams react very quickly, allowing cost savings due to short curing times. Intermediate storage of components to allow curing of the foam gaskets is unnecessary.

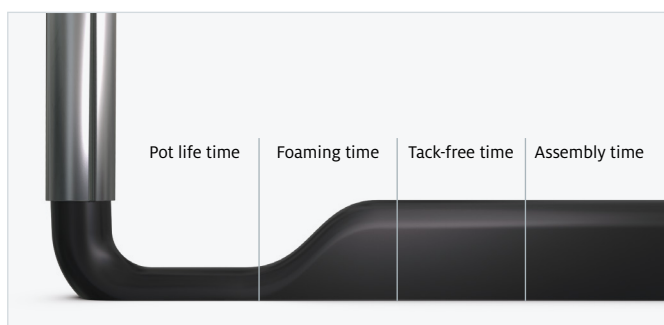

The different reaction phases of the sealing foam in the chronological sequence

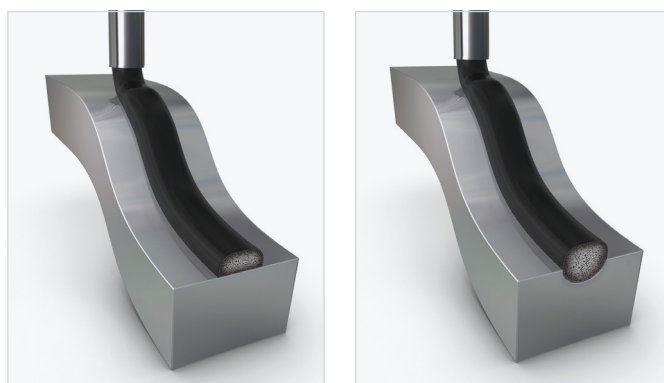

FERMAPOR K31-	A-9230-2-VP
	B-4
Mixing ratio	4 : 1
Pot life time	53 sec.
Tack-free time	8 min.
Viscosity of the A component	50,000 mPas
Density of the foam	0.3 g/cm ³
Hardness (Shore 00)	60
Temperature resistance	from -40 to +80 °C
Pretreatment	Adheres well to powder-coated surfaces. Improve adhesion by pretreatment with plasma, corona, flame treatment or primer.

The precision-contour, robot-controlled Formed-In-Place Foam Gasket (FIPFG) application process is crucial for the exact application of sealing foams, which sometimes involves dispensing very small quantities into the often very narrow housing groove of the terminal boxes. This is done with our fully automatic DM 502 mixing and dosing machine. High-viscosity thixotropic sealing foam, which can be applied in a stable manner, is used for metered application to the 2 or 3-dimensional application surfaces of the terminal boxes.

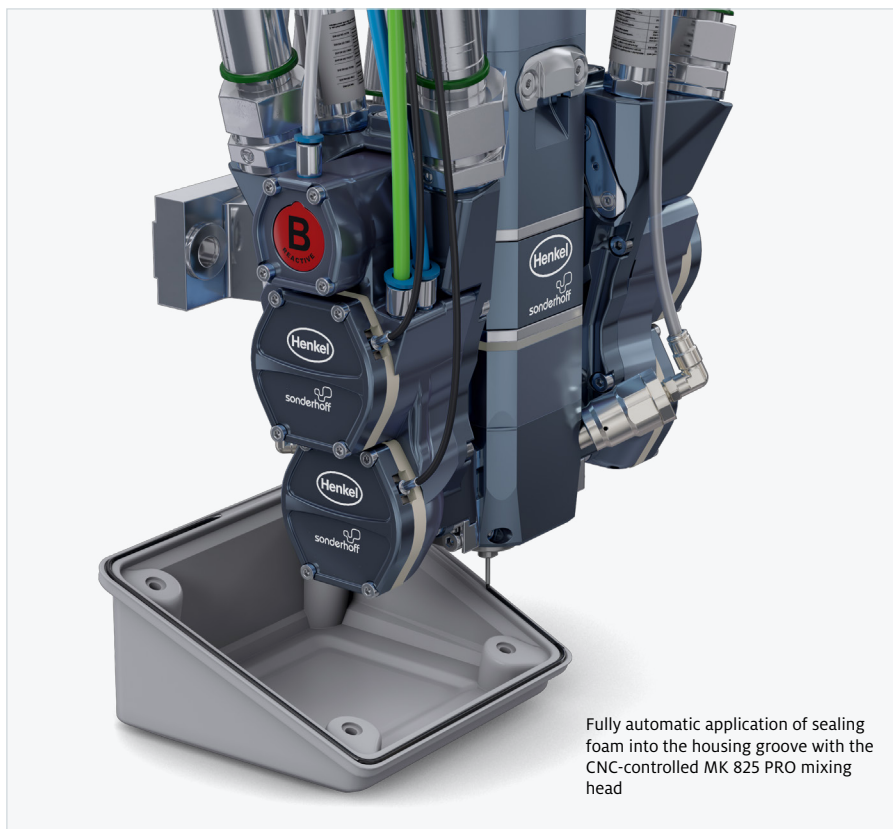

Cross-section of a polyurethane foam bead – unpressed



Cross-section of a polyurethane foam bead with 50% compression

During final assembly of the terminal box, the foam gasket applied is evenly compressed over the entire housing contour, resulting in a high degree of tightness once installed, in accordance with IP protection classes or NEMA.

Due to its excellent resetting ability of the foam sealing behavior, the mixed-cell foam structure of the polyurethane seal can still be compressed even after years (tested according to DIN EN ISO 1856). This allows frequent opening and re-closing of the terminal box for maintenance purposes, while maintaining a consistent sealing effect of the foam gasket.



Cross-section of a polyurethane foam bead in the groove without pressing

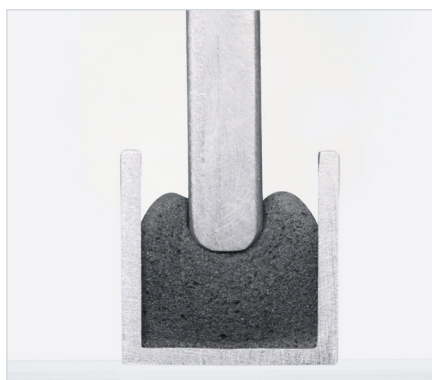

Cross-section of a polyurethane foam bead in the groove and pressed to approx. 50 %

Flexible and fully automatic – according to your requirements

Mixing and dosing system with 3-axis linear robot and a shuttle table for picking up parts

As process experts, we support you with tailored advice for the automation of your manufacturing processes. To achieve this, we offer numerous configuration and equipment options for semi-automatic or fully automatic production systems.

The reference configuration shown here for sealing the housings of terminal boxes for the electrical supply of electric motors consists of the DM 502 mixing and dosing system with the LR-HE plus 3-axis linear robot and the WT 1-LEVEL shuttle table for picking up parts. The two pick-up plates working in shuttle mode enable the workpieces to be picked up and alternately processed in a single plane. This makes it possible to guarantee continuous operation.

The electric motor terminal box housing to be sealed is positioned and fixed in place on the shuttle table either by a machine operator, who can also check the parts for quality, or by a Pick & Place Robot. In the latter case, an optionally installed camera or sensor system could carry out the quality control of the parts.

For small to larger terminal boxes, thixotropic sealing material is dispensed into the groove of the three-dimensional housings or lids via the CNC-controlled MK 825 PRO precision mixing head. The dosing process must be very precise, especially when dealing with very narrow grooves. After the dosing cycle, the coupling point of the room-temperature-curing foam gasket closes seamlessly and is almost invisible. Even with short cycle times and high unit numbers, the material application process using the FIPFG method is carried out with high dosing precision and repeat accuracy. As a result, you achieve foam gaskets of uniformly high quality.

In addition, our fail-safe mixing and dosing system can be operated easily and intuitively without the need for extensive training. Thanks to the automatic logging of dosing program data, all process data can be traced and evaluated by the machine operator via the CONTROL 2 operating panel while production is running.

In all solutions, our main focus is on extremely reliable plant engineering, minimized maintenance times and consistent dosing quality.



Optionally available: **Touchscreen control panel CONTROL 2** (21.5") for operating the dosing system



Shuttle/sliding table
Two pick-up plates operating in pendulum mode in one plane

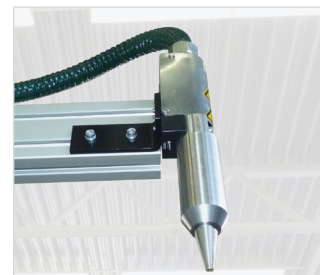

The optional **plasma nozzle** mounted on the CNC linear robot applies the plasma before the seal is applied.



Highly efficient **LR-HE plus 3-axis linear robot** for precise guidance of mixing heads for the application of polymer reaction materials. The Omega toothed belt drive enables high application speeds for components with medium and large radii.

Separately installed **material pressure tanks** (24 l or 44 l, single-walled or double-walled) with minimum level sensors, on a grating platform with adjustable leveling feet and drip tray

Optional: Automatic **SUPPLY TAB drum refilling station** for low-viscosity products, e.g. isocyanate (**B component**)

Optional: Automatic **ELEVATOR drum refilling station** for the **A component** with pneumatic lift and agitator

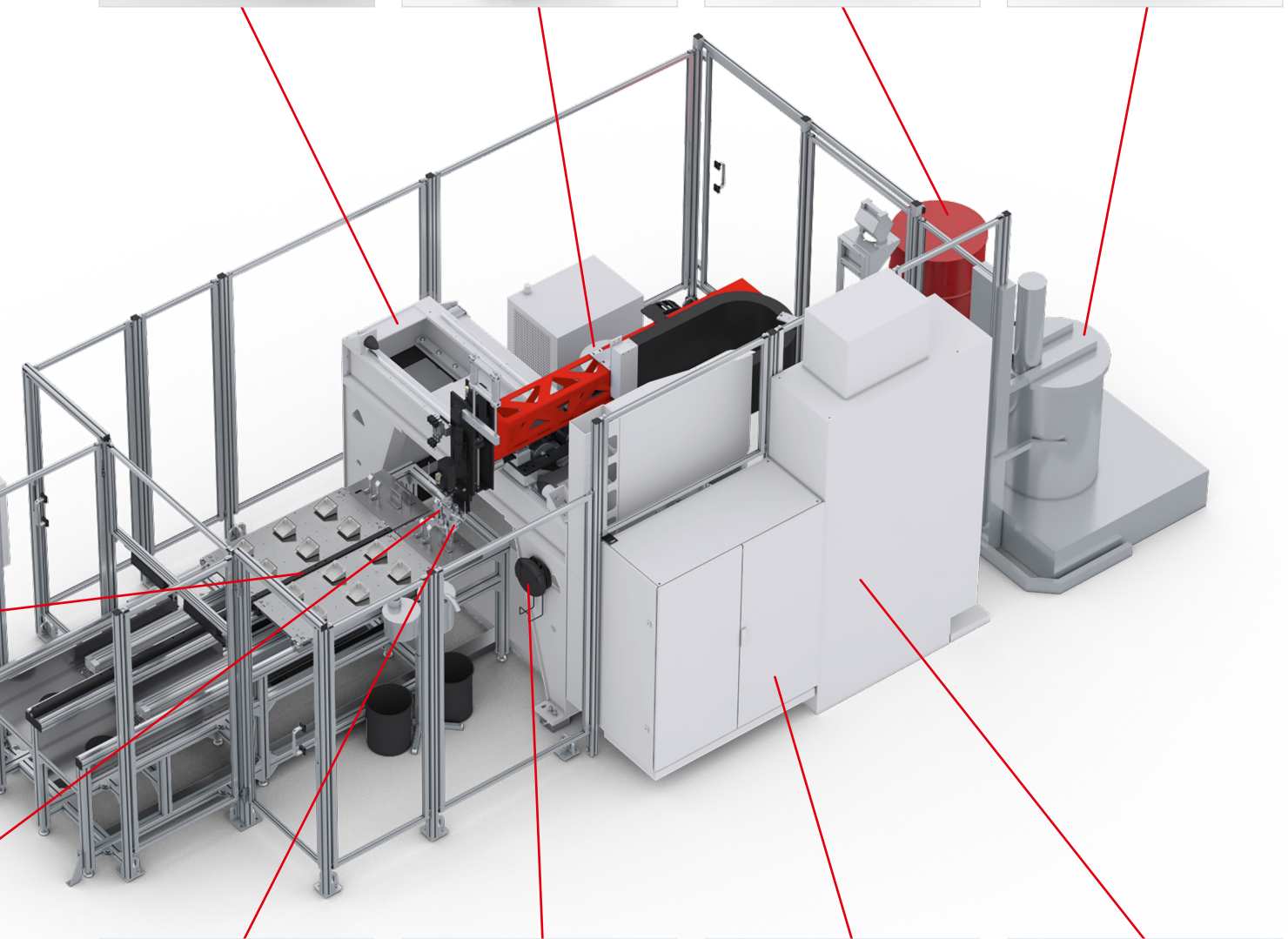
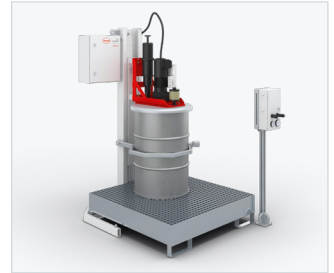

Precision mixing head MK 825 PRO with high-pressure water rinsing



The multifunctional **Mobile Panel MP 2** (10.1" WXGA TFT) enables convenient operation of the dosing system.



The **dosing machine cabinet** contains the components of the dosing periphery, e.g. the dosing pumps.

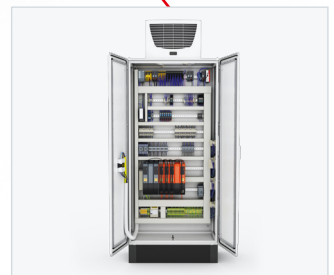

The control electronics, safety engineering and industrial PC are installed in the **control cabinet**.

This is why you should use the FIPFG technology in your production process



Advantages of the Formed-In-Place Foam Gasket Technology

- › Sealing standard in many industrial sectors
- › Highly accurate material application controlled by contour robots
- › Processing and full curing at room temperature
- › Perfect coordination of the material system and dosing system
- › Suitable for 2D and complex 3D part geometries
- › More efficient use of materials compared to punched seals
- › Cheaper compared to 2-C injection molding, as there are no tooling costs
- › High degree of future viability, due to suitability for use in a wide variety of industries & applications



Advantages of our mixing and dosing machines

- › Combination of processes (bonding, foaming, caulking, potting)
- › High flexibility of the dosing system
- › Simple, intuitive operation
- › Automatic material preparation incl. handling
- › High dosing and repeat accuracy
- › Short machine downtimes and cycle times
- › Fine-cell foam structure due to dynamic mixing
- › Reproducible foam quality
- › Ecological high-pressure water rinsing
- › Easy maintenance



Advantages of our FIPFG foam gaskets

- › More cost-effective than compact systems due to lower foam density
- › Seamless seal / hardly visible coupling point
- › Compensation of component tolerances
- › Good resilience
- › Multiple compression and release processes possible
- › Broad range of properties / wide variety of recipes
- › Individually adaptable recipes
- › Good form fit to the component contour
- › Resistant to moisture, dust, temperature & media
- › Flame-retardant according to UL 94
- › IP classes up to IP 68 or NEMA 4 to 6 and NEMA 12
- › Special PU foam with low VOC emissions
- › Very fast reacting PU foam (Fast-Cure)

Perfectly coordinated solutions of material, machine and contract manufacturing

With its Sonderhoff brand, Henkel has not only acquired many years of experience in the manufacture of tailor-made two-component sealing systems and mixing and dosing machines, but also as a process expert for application-specific material application using the FIPFG (Formed-In-Place-Foam-Gasket) technology.

With the Sonderhoff portfolio, we offer you the advantages of a system provider from a single source and the solutions to meet your technical and commercial challenges.

With the dosing technology that is tailored to our sealing foams, we ensure efficient production processes in accordance with the requirements of fully automated series production.

If you would like to take advantage of all the benefits of the FIPFG technology for your production in a flexible, fast, uncomplicated manner and without having to make your own acquisition investments, we can provide expert sealing for your components at one of our contract manufacturing sites worldwide. There, the spectrum ranges from the sampling of prototypes and small batch series to production scale manufacturing.

The choice is yours! You can either decide in favor of our all-inclusive package, consisting of material, machine and contract manufacturing, supported by application advice, sampling and training or you can choose the individual solutions that suit you best. We combine our products and services from a single source in such a way that you receive the optimum solution for your requirements profile.

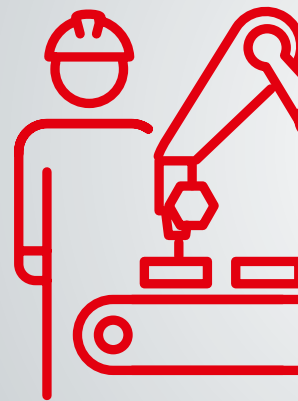

MANUFACT

Flexibility & Precision

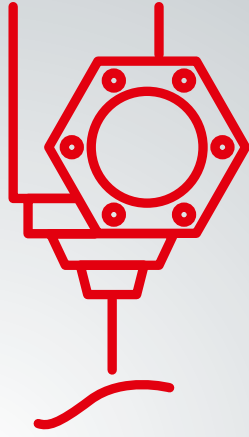

EQUIPMENT

Automation Solutions

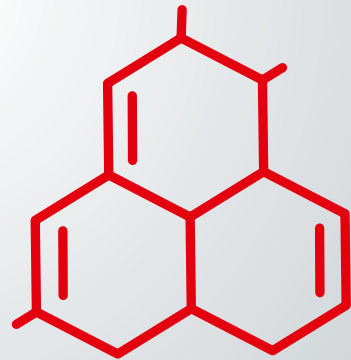

MATERIALS



URING

Customer-specific solutions – worldwide and for many industries

The Henkel specialists for the Sonderhoff portfolio
are available globally

KOLO, POLAND
External Subcontracting Location

DÜSSELDORF, GERMANY
Center of Expertise

ELGIN, ILLINOIS, USA
Regional Hub

RICHMOND (KANSAS CITY), USA
Regional Hub

DORNBIRN, AUSTRIA
Center of Expertise

BARCELONA, SPAIN
External Subcontracting Location

OGGIONO, ITALY
Regional Hub

INCHEON, KOREA
External Subcontracting Location

SHANGHAI, CHINA
Regional Hub

PUNE, INDIA
Regional Hub

PUNE, INDIA
External Subcontracting Location

SÃO PAULO, BRAZIL
External Subcontracting Location

Global presence



Every year, more than 300 million seals are manufactured in more than 50 countries using products from Henkel's Sonderhoff portfolio. At our Centers of Expertise and Regional Hubs, our specialists offer application engineering advice, e.g. selecting a suitable material system and sampling of your components, as well as project management for dosing systems and automation. You will receive training from us on how to use the FIPFG technology and we will support you with the selection of spare parts and a regular service offering. Furthermore, we will be pleased to take over parts of your production for you – from small to large series – at our subcontracting locations.

Sales staff at all other Henkel locations worldwide will also be happy to answer any questions and provide you with further information on our sealing, bonding, and potting solutions. We look forward to hearing from you.



Henkel AG & Co. KGaA

Henkelstraße 67
40589 Düsseldorf
Germany
Tel.: +49 211 797-0
Fax: +49 211 798 4008

www.henkel.com
www.sonderhoff.com

Get in contact with us



The description of the possible fields of use of our products as well as the technical data and values only have a general character and do not mean that a certain product can be used under all conditions in the respective field of use. In this respect, the stated field of use is not a binding specification or usage provision. Due to the great number of environment variables and their influences (e.g. temperature, test specimens, size, interaction with substrates, influence of machines, or the like) you as our customer must check whether the product is suitable for your specific field of use. We will be pleased to assist and advise you in this respect. Except as otherwise noted, all marks used above are trademarks and/or registered trademarks of Henkel and its affiliates in the U.S., Germany and elsewhere.

© 8.2024 Henkel AG & Co. KGaA. All rights reserved