

SEALING OF VEHICLE LIGHTS



Reliably sealed vehicle lights for clear vision

Vehicle lighting has the central task of ensuring optimal illumination for greater driving comfort and better safety for all road users. This applies both to “seeing” and to “being seen”, regardless of the time of day or weather conditions. Reliable sealing of the light housing ensures that no moisture penetrates and impairs the light intensity of the vehicle light. Alongside conventional halogen and the xenon headlamps, that have been used for many years, new technologies are becoming prevail. LED systems and laser lighting have smaller space requirements and provide extreme durability. This makes possible completely new design options for vehicle lights and increases the attractiveness of newer car models.

Leading vehicle light manufacturers have relied for years on our Formed-In-Place-Foam-Gasket (FIPFG) sealing technology and wide range of innovative material systems for sealing and bonding front and fog lights, tail lights and third brake lights.

Are you looking for an efficient system solution for bonding and sealing light housings for your production line?

We provide you with a cost-efficient, individualized sealing solution with a sealing foam or adhesive that fits your requirements, and a perfectly matched mixing and dosing systems. The foam or adhesive application controlled by a contour robot is fully automatic, highly precise and stable under process conditions.

Do you need a flexible dosing system and automation engineering that adapts to your production requirements?

The modular design of our mixing and dosing systems with their peripheral interfaces allows flexible use, with excellent integration into existing production concepts. With its high dispensing accuracy and systematic, sensor based process monitoring our efficient mixing and dosing system is very easy and intuitive to operate. In addition, we can also configure for you a multi-component dosing machine, which can be used for seal foaming as well as for bonding or potting.

As a process expert for FIPFG technology, we have many years of experience in sealing and bonding vehicle lights with different lighting technology.



Customized sealing solutions for third brake lights

We develop individually for your specific requirements

To ensure that your innovative vehicle lighting systems can function reliably, we offer you efficient and flexible sealing solutions to meet your individual requirements. Our 2-component sealing foam is installed and compressed in the overall part construction of the vehicle light. This keeps moisture away from the light sources and thus avoids the risk of lighting electronics corroding. The polyurethane based 2-component sealing foams can be applied to a wide range of applications on cars, vans and trucks: front headlights, tail lights, third brake lights, turn signals, rear fog lights, license plate lights and multifunctional lights.

Third brake lights, installed in rear spoilers or on rear windows with 2-dimensional and 3-dimensional geometry are often sealed using the FERMAPOR K31 thixotropic polyurethane foams, because these adapt excellently to the 3D contour. Using the FIPFG process, our dosing equipment applies a small, fine foam bead to the contact surface or in the groove, ensuring reliability under process conditions and stability guaranteed by the high foam viscosity. FERMAPOR K31 seals are therefore ideally suited for a majority of designs of third brake lights. Although we can produce the sealing material in a variety of colors, the seal in this case is typically red in color and not visible under the red cover of the brake light.

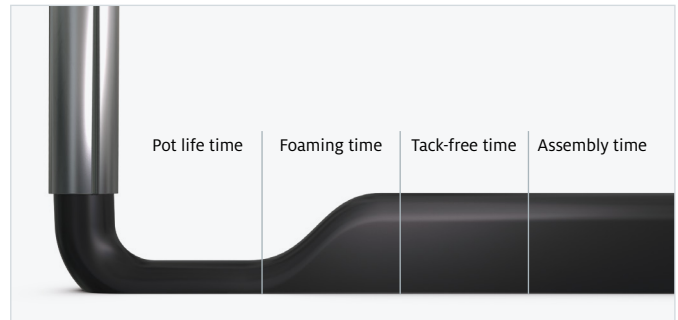

The different reaction phases of the sealing foam in the chronological sequence



Thixotropic seal 2D without groove

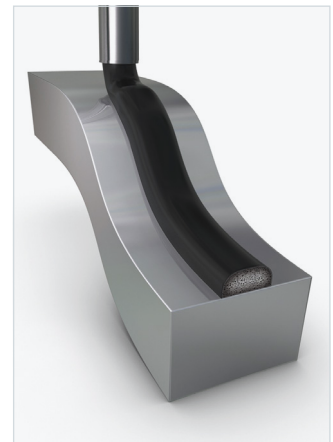

Thixotropic seal 3D without groove

FERMAPOR	K31-A-9212-1-red	CC-A-5530-2-B
	K31-B-81	CC-B-66
Mixing ratio	3.7 : 1	2.3 : 1
Pot life time	30 sec.	n/a
Tack-free time	5 min.	16 min.
Viscosity of A component	46,000 mPas	70,000 mPas
Density of the foam	0.25 g/cm ³	0.31 g/cm ³
Hardness (Shore 00)	36	55
Temperature resistance	from -40 to +80 °C	from -40 to +80 °C
Pretreatment	Primer P23 (solvent-based), P13 (water-based) or plasma	Primer P23 (solvent-based), P13 (water-based) or plasma



Cross-section of a polyurethane foam bead – unpressed

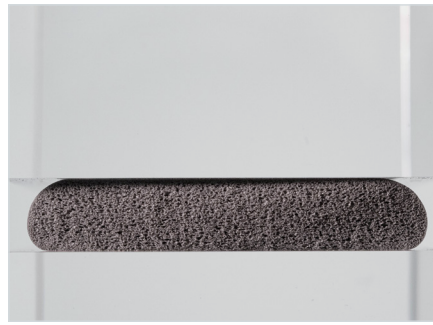

Cross-section of a polyurethane foam bead with 50% compression

Our polyurethane foams are highly water-repellent and temperature-resistant from -40 to +80 °C. They achieve particularly good adhesion to the contact surfaces of common plastic materials. For plastics such as PP or PE, adhesion is often achieved through additional pretreatment with plasma or primer. Due to excellent long-term behavior and the very high resilience of the foam gasket, repeated removal and installation of third brake lights for repair purposes is possible without the sealing effect decreasing. To compensate for component tolerances, the polyurethane foam can be easily compressed during assembly thanks to a mixed-cell foam structure with low installation forces. We can modify our formulations to meet many of your requirements.



3D third brake light, without groove, with red polyurethane foam gasket



2D third brake light, with red polyurethane foam gasket

Flexible and fully automatic – according to your requirements

DM 502 mixing and dosing system with 6-axis robot and mixing head for foam application and shuttle table for picking up parts for the third brake lights

The reference configuration shown here for sealing the housings of third brake lights consists of our DM 502 mixing and dosing system with 6-axis robot and MK 825 PRO precision mixing head for foam application as well as a WT 1-LEVEL shuttle table for picking up parts. The two pick-up plates working in pendulum mode enable the workpieces fixed there to be picked up and processed in one plane. This makes it possible to guarantee continuous operation.

The placement and holding on the shuttle table of the third brake light housing to be sealed is performed either by a machine operator, who can also check the parts for quality, or by a Pick & Place Robot. In this case, an optionally installed camera system could carry out the quality control of the parts.

For sealing third brake lights, FERMAPOR K31 thixotropic polyurethane sealing foam is applied via the nozzle injector of the MK 825 PRO precision mixing head mounted on the robot arm, in a high-precision and fully automatic process, onto the 2D or 3D application surface or into the groove of the component contour. After the dosing cycle, the coupling point of the foam gasket closes almost seamlessly and is thus virtually invisible. Due to the uniform compression in the installed state, a high level of tightness is achieved over the entire contour of the third brake light.

For improved adhesion of the foam gasket to plastics such as PP or PE using plasma, we install an optional plasma application unit on the robot arm in addition to the mixing head.

Even with short cycle times and high unit numbers, the material application process using the FIPFG method is carried out with high dosing precision and repeat accuracy. As a result, you achieve foam gaskets of uniformly high quality. This means that your sealed third brake lights can be processed rapidly, right through to final assembly. This saves time and money.

In addition, our fail-safe mixing and dosing system can be operated easily and intuitively without the need for extensive training. Due to the automatic logging of dosing program data, all process data can be traced and evaluated by the machine operator while production is running.

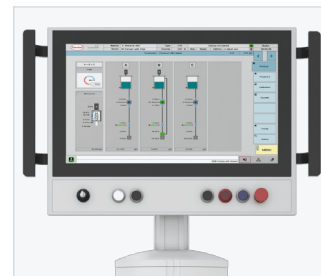

Optionally available: **CONTROL 2 touchscreen operating panel** (21.5") for operating the dosing system



WT 1-LEVEL shuttle / sliding table
Two pick-up plates operating in pendulum mode in one plane



The multifunctional **MP 2 mobile panel** (10.1" WXGA TFT) enables convenient operation of the dosing system.

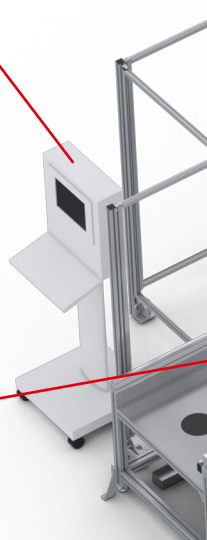

MK 825 PRO precision mixing head with high-pressure water rinsing

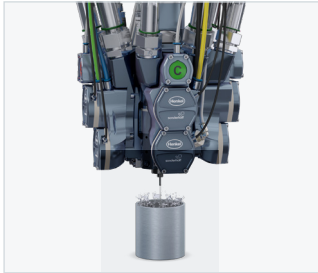

The control electronics, safety engineering and industrial PC are installed in the **control cabinet**.



Optional: Automatic **ELEVATOR drum refilling station** for the **A component** with pneumatic lift and agitator



Optional: Automatic **SUPPLY TAB drum refilling station** for low-viscosity products, e.g. isocyanates (**B component**)

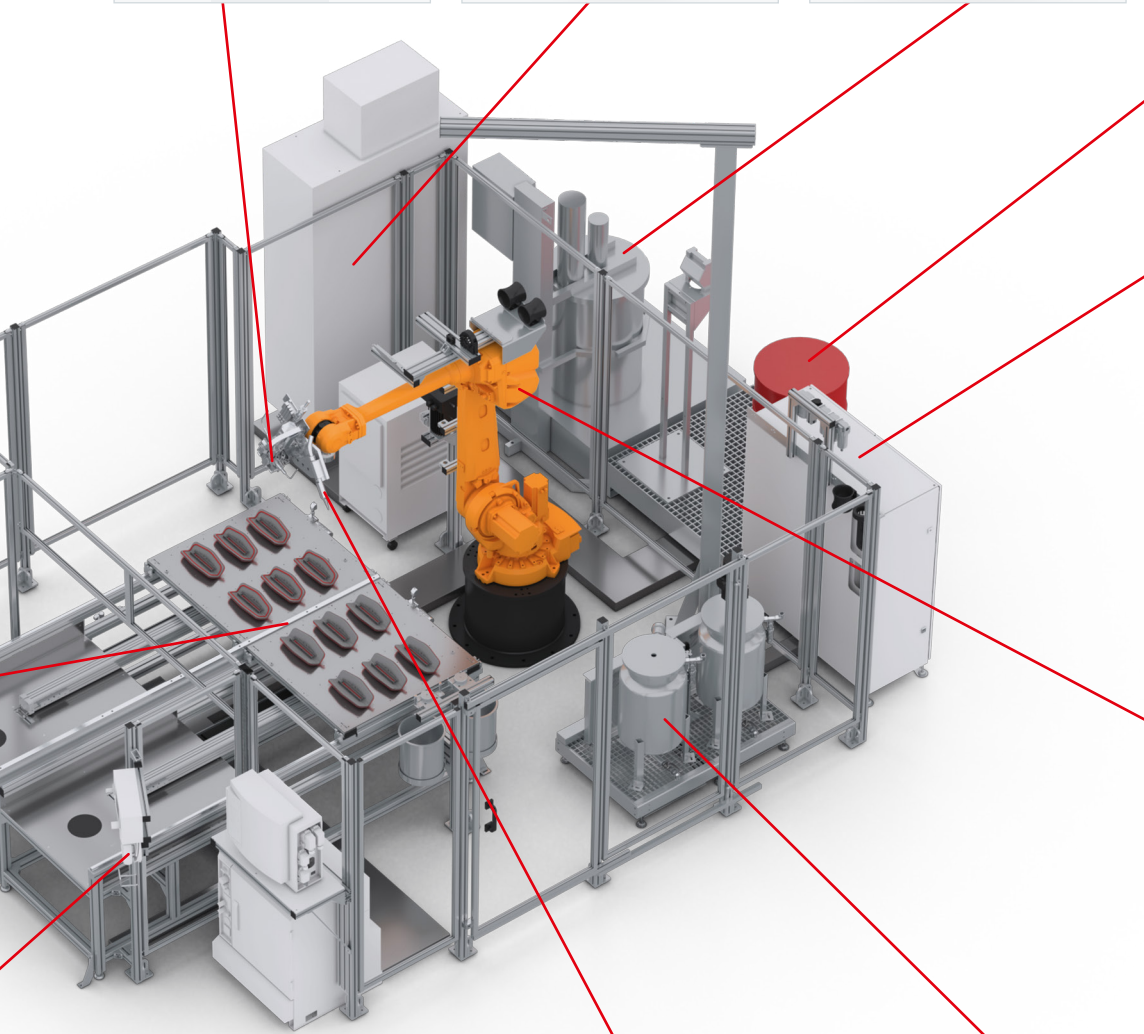

The **dosing machine cabinet** contains the components of the dosing periphery, e.g. the dosing pumps.

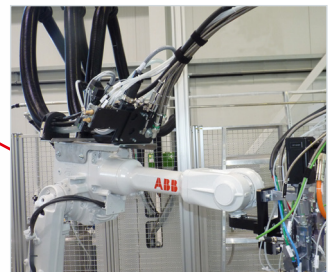

The **6-axis robot** guides the mixing head precisely over the contours of the component during the dosing process.

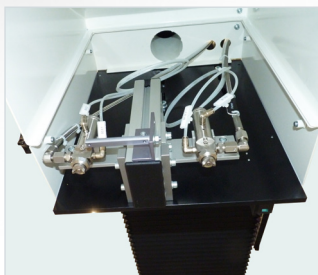

The optional **primer nozzle** mounted on the robot arm applies the primer parallel to the seal application on powder-coated or stainless steel surfaces in the same contour.

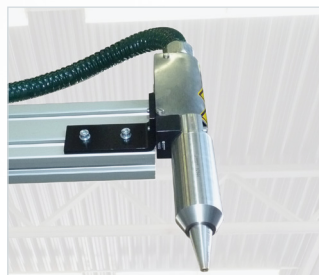

The optional **plasma nozzle** mounted on the robot arm applies the plasma parallel to the seal application on plastic surfaces of the component in the same contour.



Material pressure tanks (24 l or 44 l, single-walled or double-walled) with minimum level sensors, on a grating platform with adjustable leveling feet and drip tray

Customized sealing solutions for tail lights

We develop individually for your specific requirements

We offer efficient and flexible sealing and bonding solutions to meet your individual requirements for tail lights. Our 2-component sealing foam is installed and compressed in the overall part construction of the vehicle light. This keeps moisture away from the light sources and avoids the risk of lighting electronics corroding.

Tail lights are functional design elements that hug the car's contours and give each model a distinctive look. The foam gaskets used to seal 3-dimensional tail lights must follow these contours so that the plastic parts are sealed against both the outside environment and auto body. However, conventional gaskets made of punched sponge rubber sheets commonly used for sealing 2-dimensional components are not effective. In addition, the punching waste from this process is costly and not sustainable. Our thixotropic 2-component polyurethane foam systems FERMAPOR K31 are thus used for sealing 3-dimensional tail lights. Almost 100 percent of the sealing foam consumed is actually used.

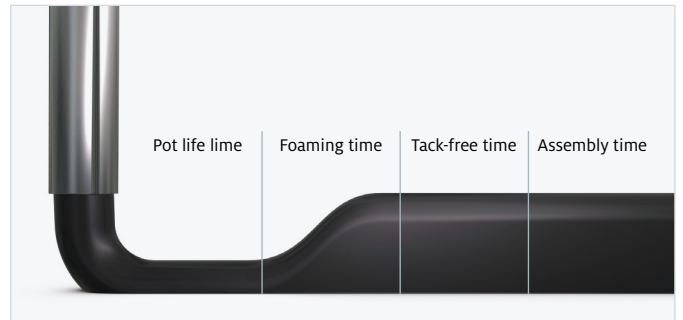

The different reaction phases of the sealing foam in the chronological sequence



Thixotropic seal 2D without groove

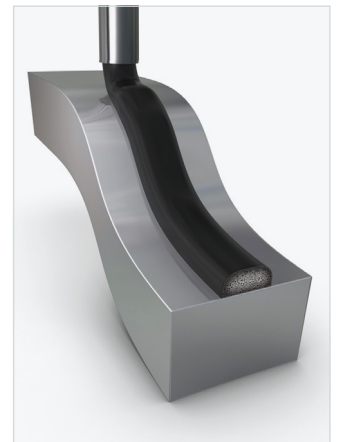

Thixotropic seal 3D without groove

FERMAPOR	K31-A-5555-1	CC-A-5530-2-B
	K31-B-4	CC-B-66
Mixing ratio	4 : 1	2.3 : 1
Pot life time	35 sec.	n/a
Tack-free time	4 min.	16 min.
Viscosity of A component	55,000 mPas	70,000 mPas
Density of the foam	0.27 g/cm ³	0.31 g/cm ³
Hardness (Shore 00)	54	55
Temperature resistance	from -40 to +80 °C	from -40 to +80 °C
Pretreatment	Primer P23 (solvent-based), P13 (water-based) or plasma	Primer P23 (solvent-based), P13 (water-based) or plasma



Cross-section of a polyurethane foam bead – unpressed



Cross-section of a polyurethane foam bead with 50% compression

Our dosing machines apply the FERMAPOR K31 foams to the 3-dimensional contour of the lighting housing in a fully automatic and high-precision FIPFG process. This creates a seamless gasket with an almost invisible coupling point of the foam gasket. Thanks to its high viscosity, the paste-like foam remains stable even on sloping contours. FERMAPOR K31 gaskets are ideally suited for practically all tail light designs.

Repeated removal and installation of tail lights for repair and maintenance purposes is possible without the sealing effect weakening, thanks to the very high resilience of the foam gasket and its excellent long-term behavior. To compensate for component tolerances, the polyurethane foam can be easily compressed during assembly thanks to a mixed-cell foam structure with low installation forces. We can modify our formulations to meet many of your requirements.



Tail light with all-round polyurethane foam gasket

Flexible and fully automatic – according to your requirements

DM 502 mixing and dosing system with 3-axis linear robot and a shuttle table for picking up parts of the tail light housing

The reference configuration shown here for sealing the housings of tail lights consists of our DM 502 mixing and dosing system with LR-HD 3-axis linear robot and MK 825 PRO precision mixing head for dosing seal foam as well as the WT 1-LEVEL shuttle table for picking up parts. The two pick-up plates working in pendulum mode enable the workpieces fixed there to be picked up and processed in one plane. This makes it possible to guarantee continuous operation.

The placement and holding on the shuttle table of the tail light housing to be sealed is performed either by a machine operator, who can also check the parts for quality, or by a Pick & Place Robot. In this case, an optionally installed camera system could carry out the quality control of the parts.

For sealing the tail light housing, FERMAPOR K31 thixotropic polyurethane sealing foam is applied via the nozzle injector of the CNC-controlled MK 825 PRO precision mixing head, in a high-precision and fully automatic process, onto the 2D or 3D application surface or into the groove of the component contour. After the dosing cycle, the coupling point of the foam gasket closes almost seamlessly and is thus virtually invisible. Due to the uniform compression in the installed state, a high level of tightness is achieved over the entire contour of the tail light.

For improved adhesion of the foam gasket to plastics such as PP or PE using plasma, we install an optional plasma application unit on the rear of the CNC Y-axis in addition to the mixing head.

Even with short cycle times and high unit numbers, the material application process using the FIPFG method is carried out with high dosing precision and repeat accuracy. As a result, you achieve foam gaskets of uniformly high quality. This means that your sealed tail lights can be processed rapidly, right through to final assembly. This saves time and money.

In addition, our fail-safe mixing and dosing system can be operated easily and intuitively without the need for extensive training. Due to the automatic logging of dosing program data, all process data can be traced and evaluated by the machine operator while production is running.



Optionally available: **CONTROL 2 touchscreen operating panel** (21.5") for operating the dosing system



WT 1-LEVEL shuttle / sliding table
Two pick-up plates operating in pendulum mode in one plane



The multifunctional **MP 2 mobile panel** (10.1" WXGA TFT) enables convenient operation of the dosing system.

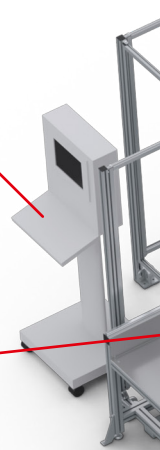

Highly dynamic **LR-HD 3-axis linear robot** for precise guidance of mixing heads for the application of polymer reaction materials. The rack and pinion drive with high stiffness and acceleration enables dynamic application speeds.



Separately installed **material pressure tanks** (24 l or 44 l, single-walled or double-walled) with minimum level sensors, on a grating platform with adjustable leveling feet and drip tray



Optional: Automatic **SUPPLY TAB drum refilling station** for low-viscosity products, e.g. isocyanates (**B component**)



Optional: Automatic **ELEVATOR drum refilling station** for the **A component** with pneumatic lift and agitator

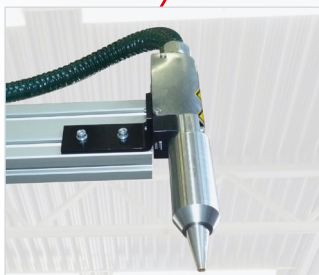
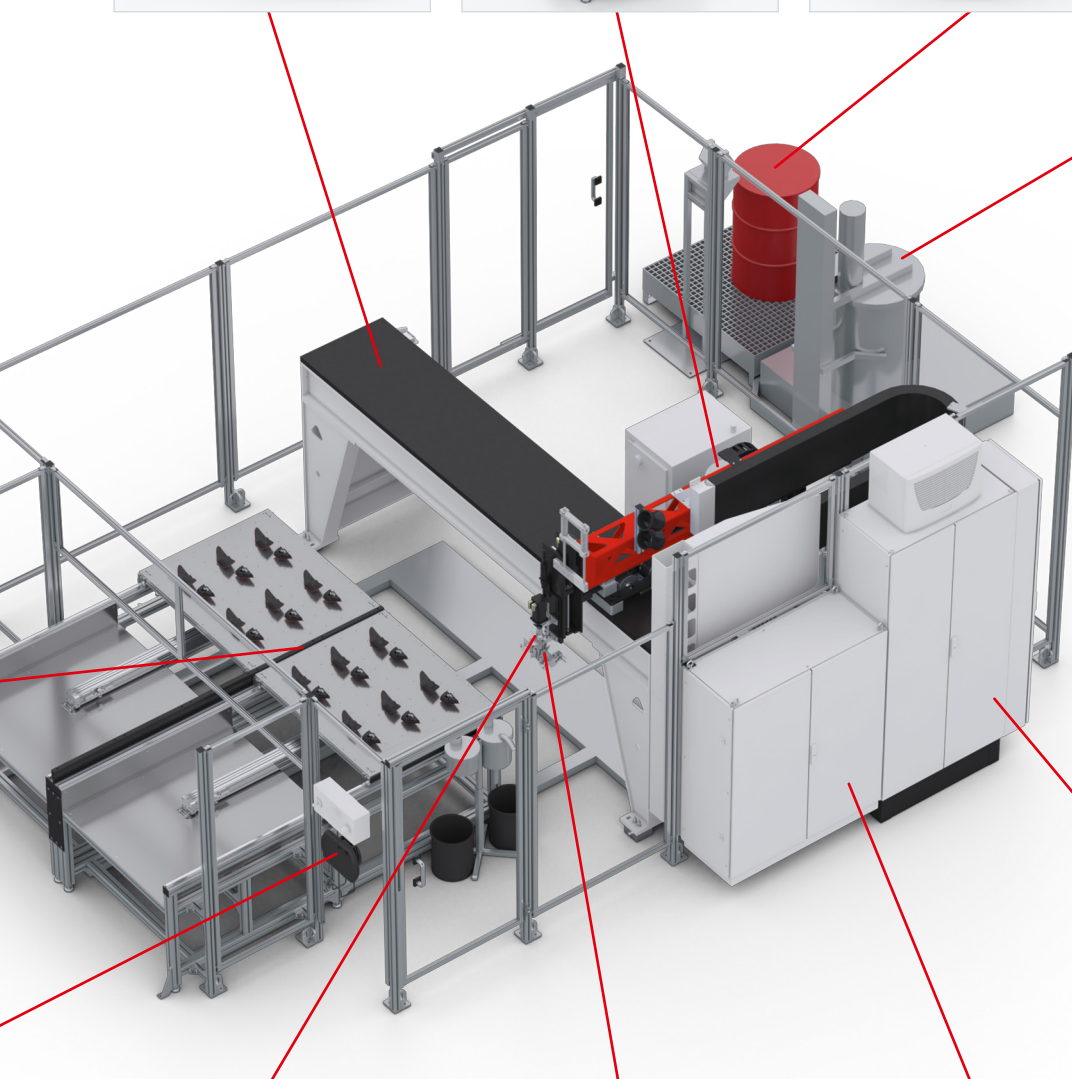

The optional **plasma nozzle** mounted on the back of the CNC Y-axis applies the plasma in parallel to the seal application onto plastic surfaces of the component in the same contour.



MK 825 PRO precision mixing head with high-pressure water rinsing

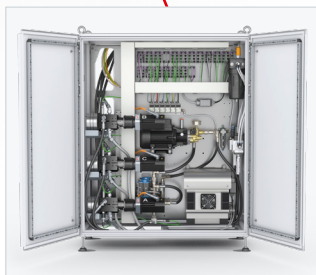

The **dosing machine cabinet** contains the components of the dosing periphery, e.g. the dosing pumps.

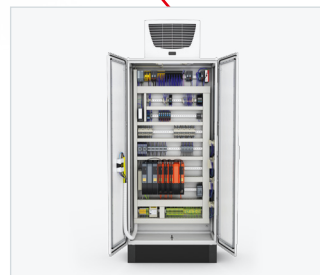

The control electronics, safety engineering and industrial PC are installed in the **control cabinet**.

Customized sealing solutions for headlights

We develop individually for your specific requirements

We offer efficient and flexible sealing solutions to meet your individual requirements for headlights. Our 2-component sealing foam is installed and compressed in the overall part construction of the vehicle light. This keeps moisture away from the light sources and avoids the risk of lighting electronics corroding.

Even though headlights with xenon, LED and laser light technology now represent state-of-the-art vehicle lighting in many markets, there are still countries where cars are sold with conventional headlight technology. Our customers use FERMAPOR K31 2-component polyurethane foams for sealing these conventional headlights, which are characterized by excellent long-term behavior and very high resilience of the foam structure. The backcap on the back of the headlight can be opened and closed again at any time, e.g. to change the H7 bulb, without the sealing effect weakening. To compensate for component tolerances, the polyurethane foam can be easily compressed during assembly thanks to a mixed-cell foam structure with low installation forces.

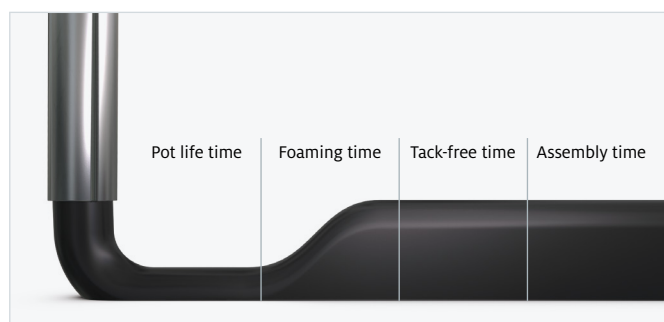

The different reaction phases of the sealing foam in the chronological sequence



Thixotropic seal 2D without groove

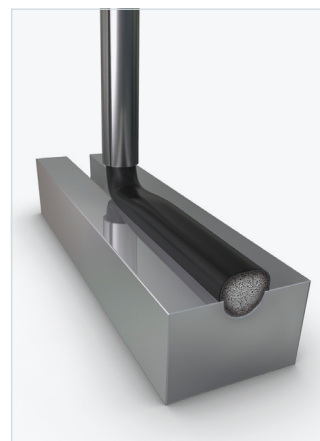

Thixotropic seal 2D with groove

FERMAPOR	K31-A-5555-1	CC-A-5530-2-B
	K31-B-4	CC-B-66
Mixing ratio	4 : 1	2.3 : 1
Pot life time	35 sec.	n/a
Tack-free time	4 min.	16 min.
Viscosity of A component	55,000 mPas	70,000 mPas
Density of the foam	0.27 g/cm ³	0.31 g/cm ³
Hardness (Shore 00)	54	55
Temperature resistance	from -40 to +80 °C	from -40 to +80 °C
Pretreatment	Primer P23 (solvent-based), P13 (water-based) or plasma	Primer P23 (solvent-based), P13 (water-based) or plasma



Cross-section of a polyurethane foam bead in the groove without compression



Cross-section of a polyurethane foam bead in the groove and compressed to approx. 50%

Conventional sponge rubber seals are usually much harder than polyurethane sealing foam and are not so easy to install. This requires a multi-step process as the sponge rubber cords must be first cut to length and the cut edges glued. In the case of compression, the adhesive joint is usually much harder than the gasket and also has a much lower resilience.

Our polyurethane foams can be adjusted to make very soft and seamless gaskets with an almost invisible coupling point of the foam gasket. Economic comparison shows that the use of foam gaskets, which generally have lower density and thus require less material per gasket, ultimately has a favorable effect on unit cost comparison.



Headlight backcap with circumferential polyurethane foam gasket

Flexible and fully automatic – according to your requirements

DM 502 mixing and dosing system with 3-axis linear robot and a shuttle table for picking parts of the headlight backcaps

The reference configuration shown here for sealing the backcaps of headlights consists of our DM 502 mixing and dosing system with LR-HE plus 3-axis linear robot and MK 825 PRO precision mixing head for dosing seal foam as well as the WT 1-LEVEL shuttle table for picking up parts. The two pick-up plates working in pendulum mode enable the workpieces fixed there to be picked up and processed in one plane. This makes it possible to guarantee continuous operation.

The placement and holding on the shuttle table of the headlight housing to be sealed is performed either by a machine operator, who can also check the parts for quality, or by a Pick & Place Robot. In this case, an optionally installed camera system could carry out the quality control of the parts.

For sealing the headlights, FERMAPOR K31 thixotropic polyurethane sealing foam is applied via the nozzle injector of the CNC-controlled MK 825 PRO precision mixing head, in a high-precision and fully automatic process, onto the 2D or 3D application surface or into the groove of the component contour. After the dosing cycle, the coupling point of the foam gasket closes almost seamlessly and is thus virtually invisible. Due to the uniform compression in the installed state, a high level of tightness is achieved over the entire contour of the backcaps.

For improved adhesion of the foam gasket to plastics such as PP or PE using plasma, we install an optional plasma application unit on the rear of the CNC Y-axis in addition to the mixing head.

Even with short cycle times and high unit numbers, the material application process using the FIPFG method is carried out with high dosing precision and repeat accuracy. As a result, you achieve foam gaskets of uniformly high quality. This means that your sealed headlights can be processed rapidly, right through to final assembly. This saves time and money.

In addition, our fail-safe mixing and dosing system can be operated easily and intuitively without the need for extensive training. Due to the automatic logging of dosing program data, all process data can be traced and evaluated by the machine operator while production is running.



Optionally available: **CONTROL 2 touchscreen operating panel** (21.5") for operating the dosing system



WT 1-LEVEL shuttle /sliding table
Two pick-up plates operating in pendulum mode in one plane

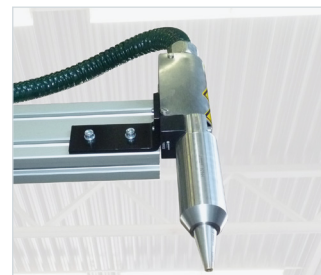

The optional **plasma nozzle** mounted on the back of the CNC Y-axis applies the plasma in parallel to the seal application onto plastic surfaces of the component in the same contour.

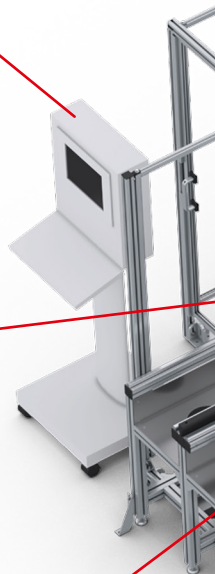

Highly efficient **LR-HE plus 3-axis linear robot** for precise guidance of mixing heads for the application of polymer reaction materials. The Omega toothed belt drive enables high application speeds for components with medium and large radii.



Separately installed **material pressure tanks** (24 l or 44 l, single-walled or double-walled) with minimum level sensors, on a grating platform with adjustable leveling feet and drip tray



Optional: Automatic **SUPPLY TAB drum refilling station** for low-viscosity products, e.g. isocyanates (**B component**)



Optional: Automatic **ELEVATOR drum refilling station** for the **A component** with pneumatic lift and agitator

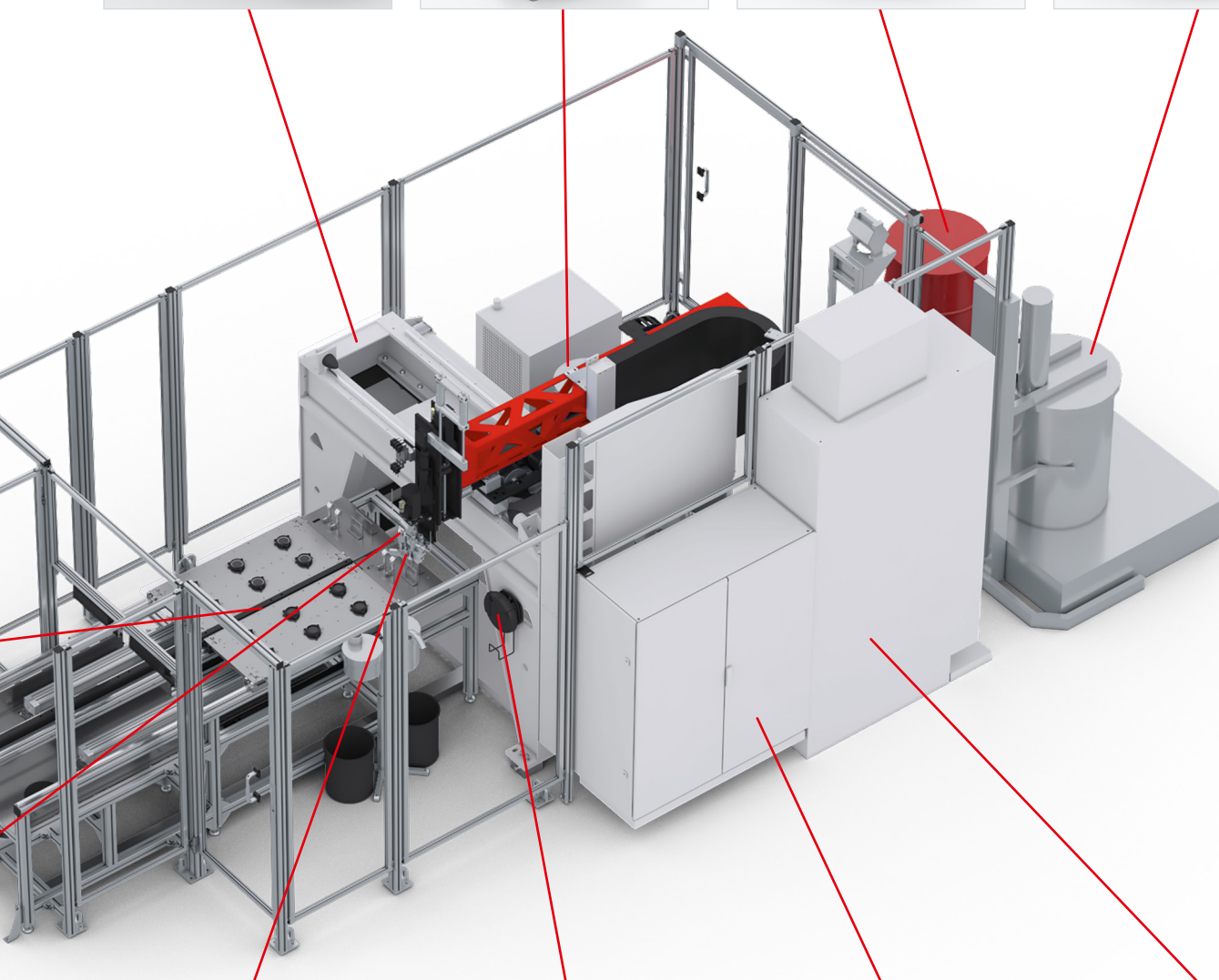

MK 825 PRO precision mixing head with high-pressure water rinsing



The multifunctional **MP 2 mobile panel** (10.1" WXGA TFT) enables convenient operation of the dosing system.

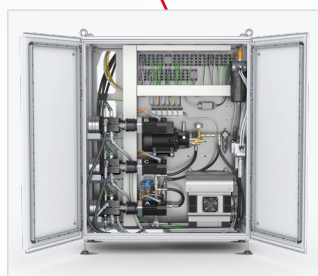

The **dosing machine cabinet** contains the components of the dosing periphery, e.g. the dosing pumps.

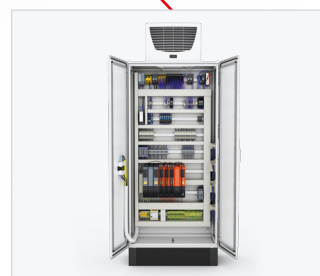

The control electronics, safety engineering and industrial PC are installed in the **control cabinet**.



The image shows a close-up of a Sonderhoff machine head, which is a specialized tool used for applying foam gaskets. The machine is silver and has the 'sonderhoff' logo in grey and teal. A red foam gasket is being extruded from the machine's nozzle, curving downwards and to the right. The background is white.

sonderhoff

This is why you should use the FIPFG technology
in your production process



Advantages of the Formed-In-Place-Foam-Gasket Technology

- › Sealing standard in many industrial sectors
- › Highly accurate material application controlled by contour robots
- › Processing and full curing at room temperature
- › Perfect coordination of the material system and dosing system
- › Suitable for 2D and complex 3D part geometries
- › More efficient use of materials compared to punched seals
- › Cheaper compared to 2K injection molding, as there are no tooling costs
- › High degree of future viability, due to solution flexibility in a wide variety of industries & applications



Advantages of our mixing and dosing machines

- › Combination of processes (bonding, foaming, potting)
- › High flexibility of the dosing system
- › Simple, intuitive human interface
- › Automatic material preparation incl. handling
- › High dosing and repeat accuracy
- › Short machine downtimes and cycle times
- › Fine-cell foam structure due to dynamic mixing
- › Reproducible foam quality
- › Ecological high-pressure water rinsing
- › Easy maintenance



Advantages of our FIPFG foam gaskets

- › More cost-effective than compact systems due to lower foam density
- › Seamless seal / hardly visible coupling point
- › Compensation of component tolerances
- › Excellent resilience after compression
- › Multiple compression and release processes possible
- › Broad range of properties / wide variety of recipes
- › Individually adaptable formulations
- › Good form fit to the component contour
- › Resistant to moisture, dust, temperature & media
- › Flame-retardant according to UL 94
- › IP classes up to IP 68 or NEMA 4 to 6 and NEMA 12
- › Special PU foam with low VOC emissions
- › Very fast reacting PU foam (Fast-Cure)

Perfectly coordinated solutions of material, machine and contract manufacturing

With its Sonderhoff brand, Henkel has not only acquired many years of experience in the manufacturing of tailor-made 2-component sealing systems and mixing and dosing machines, but also process expertise for very precise material application using the FIPFG (Formed-In-Place-Foam-Gasket) technology.

With the Sonderhoff portfolio, we offer our customers the advantages of a system provider from a single source and the solutions to meet your technical and commercial challenges.

With the dosing technology that is tailored to our sealing foams, we ensure efficient production processes in accordance with the requirements of fully automated series production.

If you would like to take advantage of all the benefits of the FIPFG technology for your production in a flexible, fast, and effective manner, we provide sealing solutions for your components at one of our many contract manufacturing sites worldwide without having to make your own acquisition investments. There, the spectrum ranges from the sampling of prototypes and small batch series to production scale manufacturing.

The choice is yours! You can either decide in favor of our all-inclusive package, consisting of material, machine and contract manufacturing, supported by application advice, sampling and training or you can choose the individual solutions that suit you best. We network our products and services from a single source in such a way that you receive the optimum solution for your requirements profile.

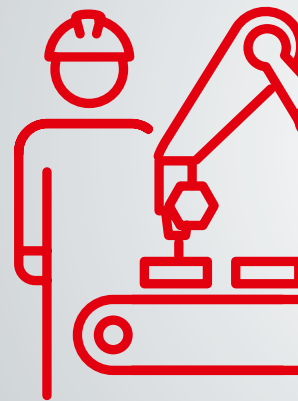

MANUFACT

Flexibility & Precision

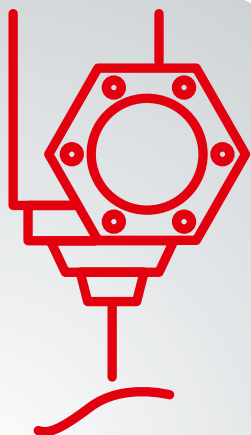

EQUIPMENT

Automation Solutions

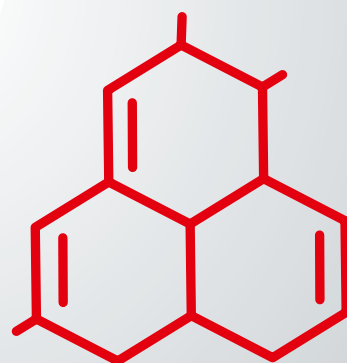

MATERIALS

MANUFACTURING

Customer-specific solutions – worldwide and for many industries

The Henkel specialists for the Sonderhoff portfolio
are available globally

KOLO, POLAND
External Subcontracting Location

DÜSSELDORF, GERMANY
Center of Expertise

ELGIN, ILLINOIS, USA
Regional Hub

RICHMOND (KANSAS CITY), USA
Regional Hub

DORNBIRN, AUSTRIA
Center of Expertise

BARCELONA, SPAIN
External Subcontracting Location

OGGIONO, ITALY
Regional Hub

INCHEON, KOREA
External Subcontracting Location

SHANGHAI, CHINA
Regional Hub

PUNE, INDIA
Regional Hub

PUNE, INDIA
External Subcontracting Location

SÃO PAULO, BRAZIL
External Subcontracting Location

Global presence



Every year, more than 300 million seals are manufactured in more than 50 countries using products from Henkel's Sonderhoff portfolio. At our Centers of Expertise and Regional Hubs, our specialists offer application engineering advice, e.g. selecting a suitable material system and sampling of your components, as well as project management for dosing systems and automation. You will receive training from us on how to use the FIPFG technology and we will support you with the selection of spare parts and a regular service offering. Furthermore, we will be pleased to take over parts of your production for you – from small to large series – at our subcontracting locations.

Sales staff at all other Henkel locations worldwide will also be happy to answer any questions and provide you with further information on our sealing, bonding, and potting solutions. We look forward to hearing from you.



Henkel AG & Co. KGaA

Henkelstraße 67
40589 Düsseldorf
Germany
Tel.: +49 211 797-0
Fax: +49 211 798 4008

www.henkel.com
www.sonderhoff.com

Get in contact with us



The description of the possible fields of use of our products as well as the technical data and values only have a general character and do not mean that a certain product can be used under all conditions in the respective field of use. In this respect, the stated field of use is not a binding specification or usage provision. Due to the great number of environment variables and their influences (e.g. temperature, test specimens, size, interaction with substrates, influence of machines, or the like) you as our customer must check whether the product is suitable for your specific field of use. We will be pleased to assist and advise you in this respect. Except as otherwise noted, all marks used above are trademarks and/or registered trademarks of Henkel and its affiliates in the U.S., Germany and elsewhere.

© 8.2024 Henkel AG & Co. KGaA. All rights reserved